

G5 Electronic Flight Instrument Pilot's Guide for Certified Aircraft (includes the GFC 500)



SYSTEM OVERVIEW

FLIGHT INSTRUMENTS

AFCS

ADDITIONAL FEATURES

INDEX

Blank Page

© 2020 Garmin Ltd. or its subsidiaries. All rights reserved.

This manual reflects the operation of System Software version 6.81 or later. Some differences in operation may be observed when comparing the information in this manual to earlier or later software versions.

Garmin International, Inc., 1200 East 151st Street, Olathe, Kansas 66062, U.S.A.

Garmin AT, Inc., 2345 Turner Road SE, Salem, OR 97302, U.S.A.

Garmin (Europe) Ltd., Liberty House, Hounsdown Business Park, Southampton, Hampshire SO40 9LR U.K.

Garmin Corporation, No. 68, Zhangshu 2nd Road, Xizhi District, New Taipei City, Taiwan

Web Site Address: www.flygarmin.com

Except as expressly provided herein, no part of this manual may be reproduced, copied, transmitted, disseminated, downloaded or stored in any storage medium, for any purpose without the express written permission of Garmin. Garmin hereby grants permission to download a single copy of this manual and of any revision to this manual onto a hard drive or other electronic storage medium to be viewed for personal use, provided that such electronic or printed copy of this manual or revision must contain the complete text of this copyright notice and provided further that any unauthorized commercial distribution of this manual or any revision hereto is strictly prohibited.

Garmin® is a registered trademark of Garmin Ltd. or its subsidiaries. This trademark may not be used without the express permission of Garmin.



BATTERY WARNINGS:

If these guidelines are not followed, the lithium-ion battery may experience a shortened life span or may present a risk of damage to the device, fire, chemical burn, electrolyte leak, and/or injury.

- *Do not leave the battery exposed to a heat source or in a high temperature environment. To help prevent damage, store the battery out of direct sunlight.*
 - *For maximum battery longevity, store within a temperature range of -4°F to 68°F (from -20°C to 20°C).*
 - *Do not use a sharp object to remove the battery.*
 - *Do not disassemble, puncture, damage, or incinerate the device or battery.*
 - *Keep the battery away from children.*
 - *Only replace the battery with the approved replacement from Garmin. Using another battery presents a risk of fire or explosion. To purchase a replacement battery, see you Garmin dealer or the Garmin website.*
 - *Contact your local waste disposal department to dispose of the device and battery in accordance with applicable local laws and regulations.*
-



WARNING: *To reduce the risk of unsafe operation, carefully review and understand all aspects of the Pilot's Guide. Thoroughly practice basic operation prior to actual use. During flight operations, carefully compare indications from the G5 to all available flight displays. For safety purposes, always resolve any discrepancies.*



WARNING: *The altitude calculated by the G5 internal GPS receiver is geometric height above Mean Sea Level and could vary significantly from the altitude displayed by pressure altimeters. Always use the pressure altitude display, when available, for determining or selecting aircraft altitude.*



WARNING: *The United States government operates the Global Positioning System and is solely responsible for its accuracy and maintenance. The GPS system is subject to changes which could affect the accuracy and performance of all GPS equipment.*



WARNING: For safety reasons, the G5 operational procedures must be learned on the ground.



WARNING: This product, its packaging, and its components contain chemicals known to the State of California to cause cancer, birth defects, or reproductive harm. This Notice is being provided in accordance with California Proposition 65. If you have any questions or would like additional information, please refer to our website at www.garmin.com/prop65



CAUTION: The display uses a lens with a special coating that may be sensitive to certain oils, waxes, and abrasive cleaners. **CLEANERS CONTAINING AMMONIA WILL HARM THE ANTI-REFLECTIVE COATING.** It is very important to clean the lens using a clean, lint-free cloth and a cleaner that is specified as safe for anti-reflective coatings. Avoid any chemical cleaners or solvents that can damage plastic components.



CAUTION: The G5 does not contain any user-serviceable parts. Repairs should only be made by an authorized Garmin service center. Unauthorized repairs or modifications could result in permanent damage to the equipment and void both the warranty and the authority to operate this device under FAA, FCC, and other applicable regulations.



NOTE: The G5 may only be installed in type-certificated aircraft in accordance with Garmin STC SA01818WI.



NOTE: The term LRU, as used throughout this manual is an abbreviation for Line Replaceable Unit. LRU is used generically in aviation for a product (such as a GSA 28 or GMC 507) that can be readily "swapped out" (usually as a single component) for troubleshooting/repair.



NOTE: *The G5 has a very high degree of functional integrity. However, the pilot must recognize that providing monitoring and/or self-test capability for all conceivable system failures is not practical. Although unlikely, it may be possible for erroneous operation to occur without a fault indication shown by the G5. It is thus the responsibility of the pilot to detect such an occurrence by means of cross-checking with all redundant or correlated information available in the cockpit.*



NOTE: *All visual depictions contained within this document, including screen images of the G5 display, are subject to change and may not reflect the most current G5 functionality.*



NOTE: *Use of polarized eyewear may cause the display to appear dim or blank.*

DECLARATION OF CONFORMITY

Hereby, Garmin declares that this product is in compliance with the Directive 2014/53/EU. The full text of the EU declaration of conformity is available at the following internet address www.garmin.com/compliance.

FCC

This device complies with Part 15 of the FCC Rules. Operation is subject to the following two conditions: (1) this device may not cause harmful interference, and (2) this device must accept any interference received, including interference that may cause undesired operation.

This equipment has been tested and found to comply with the limits for a Class B digital device pursuant to part 15 of the FCC Rules. These limits are designed to provide reasonable protection against harmful interference in a residential installation. This equipment generates, uses, and can radiate radio frequency energy and if not installed and used in accordance with the instructions, may cause harmful interference to radio communications. However, there is no guarantee that interference will not occur in a particular installation. If this equipment does cause harmful interference to radio or television reception, which can be determined by turning the equipment off and on, the user is encouraged to try to correct the interference by one of the following measures:

- Reorient or relocate the receiving antenna.
- Increase the separation between the equipment and receiver.
- Connect the equipment into an outlet on a circuit different from that to which the receiver is connected.
- Consult the dealer or an experienced radio/TV technician for help.

LICENSE AGREEMENT AND WARRANTY

CONTACT GARMIN

Contact Garmin if you have any questions while using the G5 at www.flygarmin.com.

SOFTWARE LICENSE AGREEMENT

BY USING THE DEVICE, COMPONENT OR SYSTEM MANUFACTURED OR SOLD BY GARMIN (“THE GARMIN PRODUCT”), YOU AGREE TO BE BOUND BY THE TERMS AND CONDITIONS OF THE FOLLOWING SOFTWARE LICENSE AGREEMENT. PLEASE READ THIS AGREEMENT CAREFULLY. Garmin Ltd. and its subsidiaries (“Garmin”) grants you a limited license to use the software embedded in the Garmin Product (the “Software”) in binary executable form in the normal operation of the Garmin Product. Title, ownership rights, and intellectual property rights in and to the Software remain with Garmin and/or its third-party providers. You acknowledge the Software is the property of Garmin and/or its third-party providers and is protected under the United States of America copyright laws and international copyright treaties. You further acknowledge the structure, organization, and code of the Software are valuable trade secrets of Garmin and/or its third-party providers and the Software in source code form remains a valuable trade secret of Garmin and/or its third-party providers. You agree not to reproduce, decompile, disassemble, modify, reverse assemble, reverse engineer, or reduce to human readable form the Software or any part thereof or create any derivative works based on the Software. You agree not to export or re-export the Software to any country in violation of the export control laws of the United States of America.

AVIATION LIMITED WARRANTY

All Garmin avionics products are warranted to be free from defects in materials or workmanship for the earlier of: 2 years or 800 flight hours from the date of purchase for new TSO remote-mount and TSO panel-mount products; 1 year or 400 flight hours from the date of purchase for new Non-TSO remote-mount* and Non-TSO panel-mount*, portable products and any purchased newly-overhauled products; 6 months or 200 flight hours for factory repaired or newly-overhauled products exchanged through a Garmin Authorized Service Center. Within the applicable period, Garmin will, at its sole option, repair or replace any components that fail in normal use. Such repairs or replacement will be made at no charge to the customer for parts or labor, provided the customer shall be responsible for any transportation cost. This Limited Warranty does not apply to: (i) cosmetic damage, such as scratches, nicks and dents; (ii) consumable parts, such as batteries, unless product damage has occurred due to a defect in materials or workmanship; (iii) damage caused by accident, abuse, misuse, water, flood, fire, or other acts of nature or external causes; (iv) damage caused by service performed by anyone who is not an authorized service provider of Garmin; or (v) damage to a product that has been modified or altered without the written permission of Garmin. In addition, Garmin reserves the right to refuse warranty claims against products or services that are obtained and/or used in contravention of the laws of any country.

This Limited Warranty also does not apply to, and Garmin is not responsible for, any degradation in the performance of any Garmin navigation product resulting from its use in proximity to any handset or other device that utilizes a terrestrial broadband network operating on frequencies that are close to the frequencies used by any Global Navigation Satellite System (GNSS) such as the Global Positioning Service (GPS). Use of such devices may impair reception of GNSS signals.

THE WARRANTIES AND REMEDIES CONTAINED HEREIN ARE EXCLUSIVE AND IN LIEU OF ALL OTHER WARRANTIES, WHETHER EXPRESS, IMPLIED OR STATUTORY, INCLUDING ANY LIABILITY ARISING UNDER ANY WARRANTY OF MERCHANTABILITY OR FITNESS FOR A PARTICULAR PURPOSE, STATUTORY OR OTHERWISE. THIS WARRANTY GIVES YOU SPECIFIC LEGAL RIGHTS, WHICH MAY VARY FROM STATE TO STATE.

IN NO EVENT SHALL GARMIN BE LIABLE FOR ANY INCIDENTAL, SPECIAL, INDIRECT OR CONSEQUENTIAL DAMAGES, WHETHER RESULTING FROM THE USE, MISUSE OR INABILITY TO USE THE PRODUCT OR FROM DEFECTS IN THE PRODUCT. SOME STATES DO NOT ALLOW THE EXCLUSION OF INCIDENTAL OR CONSEQUENTIAL DAMAGES, SO THE ABOVE LIMITATIONS MAY NOT APPLY TO YOU.

Garmin retains the exclusive right to repair or replace (with a new or newly-overhauled replacement product) the product or software or offer a full refund of the purchase price at its sole discretion. SUCH REMEDY SHALL BE YOUR SOLE AND EXCLUSIVE REMEDY FOR ANY BREACH OF WARRANTY.

Online Auction Purchases: Products purchased through online auctions are not eligible for warranty coverage. Online auction confirmations are not accepted for warranty verification. To obtain warranty service, an original or copy of the sales receipt from the original retailer is required. Garmin will not replace missing components from any package purchased through an online auction.

International Purchases: A separate warranty may be provided by international distributors for devices purchased outside the U.S. depending on the country. If applicable, this warranty is provided by the local in-country distributor and this distributor provides local service for your device. Distributor warranties are only valid in the area of intended distribution. Devices purchased in the U.S. or Canada must be returned to the Garmin service center in the U.K., the U.S., Canada, or Taiwan for service.



Part Number	Change Summary
190-01112-12	Initial release.

Rev	Date	Description
1	July, 2017	Production Release.
2	April, 2017	Added G5 HSI.
3	October, 2017	Added autopilot interface
A	December, 2017	Added GMC 507/GFC 500 interface Updated AFCS Status Display throughout Added Electronic Stability & Protection (ESP) Added 'Unable to Charge Battery' indication Added ability to configure Sky Pointer or Ground Pointer Other miscellaneous updates for current Software Version 5.00
B	December, 2017	Updated printing instructions
C	July, 2018	Added VNAV display capability
D	July, 2019	Added GAD 13 functionality Updated images throughout
E	August, 2019	Clerical corrections and clarifications
F	January, 2020	Updated VNAV functionality
G	November, 2020	Updated to reflect software version 6.81

- Section 1 System Overview** 3
 - 1.1 Bezel Overview** 3
 - 1.2 microSD™ Cards** 4
 - 1.3 Applying System Power** 5
 - 1.4 Operation** 5
 - 1.4.1 G5 Annunciations 5
 - 1.4.2 Backlight Intensity 8
 - 1.5 Accessing Functionality** 8
 - 1.5.1 Pages 8
 - 1.5.2 Menu 9
 - 1.6 Messages** 10
 - 1.6.1 System Messages 11

- Section 2 Flight Instruments** 13
 - 2.1 PFD Page** 13
 - 2.1.1 Airspeed Indicator 14
 - 2.1.2 Attitude Indicator 16
 - 2.1.3 Altimeter 18
 - 2.1.4 Turn Rate Indicator 20
 - 2.1.5 Heading/Ground Track (PFD Page) 20
 - 2.1.6 Vertical Speed Indicator (VSI) 22
 - 2.1.7 Battery Status Indicator 23
 - 2.2 HSI Page** 24
 - 2.2.1 Horizontal Situation Indicator (HSI) 26
 - 2.2.2 Heading/Ground Track (HSI Page) 28
 - 2.3 Navigation** 29
 - 2.3.1 Course Deviation Indicator (CDI) 29
 - 2.3.2 Vertical Deviation (Glideslope) Indicator - ILS Source 30
 - 2.3.3 Vertical Deviation (Glidepath) Indicator - GPS Source 31
 - 2.3.4 VNAV Indicator 32
 - 2.3.5 Course Selection (Optional) 32

- Section 3 Automatic Flight Control System (Optional)** 35
 - 3.1 GFC 500 AFCS Configuration** 35
 - 3.1.1 GMC 507 Mode Controller 36
 - 3.1.2 GSA 28 Servo 36
 - 3.2 AFCS System Architecture** 37
 - 3.2.1 Autopilot and Yaw Damper Operation 37
 - 3.2.2 Flight Control 38
 - 3.2.3 Pitch Axis and Trim 38
 - 3.2.4 Roll Axis 38
 - 3.2.5 Yaw Axis 38
 - 3.2.6 G5 AFCS Status Box 39

3.3 AFCS Operation	39
3.3.1 GMC 507 Controls.....	40
3.3.2 Flight Director Operation.....	43
3.3.3 Vertical Modes.....	47
3.3.4 Lateral Modes.....	57
3.4 GFC 500 AFCS Alerts	67
3.4.1 Trim Alerts.....	67
3.4.2 Speed Alerts.....	68
3.4.3 GFC 500 Messages and Annunciations.....	68
3.5 Electronic Stability & Protection (ESP) (GFC 500)	70
3.5.1 Roll Engagement.....	72
3.5.2 Pitch Engagement.....	74
3.5.3 Airspeed Protection (GFC 500 Only).....	75
Section 4 Additional Features	77
4.1 GPS Steering (GPSS)	77
4.1.1 GAD 29B (Optional).....	77
4.2 GAD 13 (Optional)	80

SECTION 1 SYSTEM OVERVIEW

The G5 Electronic Flight Instrument is installed as an attitude display indicator (ADI) and/or horizontal situation indicator (HSI). The G5 contains integrated attitude/air data sensors that provide display of attitude and secondary display of air data information. The G5 can also be interfaced to an external sensor to provide heading information. The G5 features a bright, sunlight readable, 3.5-inch color display. In the case of aircraft power loss, the G5 battery sustains the G5 flight display with up to 4 hours of power.

1.1 BEZEL OVERVIEW



Figure 1-1 G5 Bezel Overview

Control	Action	Description
Power Button	Press	Press to turn unit ON. Press and hold for 5 seconds to turn unit OFF. Once on, press to adjust the backlight.
microSD™ Card Slot		Insert microSD card to update software and log data.
Selection Knob	Press	Press to access the Menu. From the Menu, press to select the desired menu item. Press to accept the displayed value when editing numeric data or selecting from a list.
	Turn	From the Main Menu, turn the Selection Knob to move the cursor to the desired menu item. From the PFD Page, rotate to adjust the barometric setting. From the HSI Page, rotate to adjust the heading or track bug. Turn to select the desired value when editing numeric data or selecting from a list.

Table 1-1 G5 Controls

1.2 microSD™ CARDS

The G5 data card slot uses micro Secure Digital (SD) cards. The microSD™ card can be used for software updates and data logging. The maximum supported card size is 32GB.

Installing an microSD™ Card:

- 1) Insert the microSD™ card in the microSD™ card slot with the card contacts facing down (the card should be flush with the face of the bezel).
- 2) To eject the card, gently press on the microSD™ card to release the spring latch.

1.3 APPLYING SYSTEM POWER

During system initialization, the G5 displays the message 'ALIGNING' over the attitude indicator. The G5 should display valid attitude typically within the first minute of applying power. The G5 can align itself both while taxiing and during level flight.

1.4 OPERATION

1.4.1 G5 ANNUNCIATIONS

When a G5 function fails, a red 'X' is typically displayed over the instrument(s) or data experiencing the failure. Upon applying power to the G5, certain instruments remain invalid as equipment begins to initialize. All instruments should be operational within one minute of applying power. If any instrument remains flagged, and it is not likely an installation related problem, the G5 should be serviced by a Garmin-authorized repair facility .



Figure 1-2 G5 PFD Page Failure Annunciations



Figure 1-3 G5 HSI Page Failure Annunciations

1.4.1.1 G5 ATTITUDE

The G5 calculates aircraft attitude using information from its built-in inertial sensors. The G5 also uses GPS and airspeed data to provide the most accurate attitude information. The G5 should display valid attitude within the first minute of applying power.

If the G5 senses the attitude solution is valid, but not yet within the internal accuracy limits, "ALIGNING" is displayed. The displayed attitude information is still accurate and usable while this indication is shown. The G5 can align itself both while taxiing and during level flight.



Figure 1-4 Attitude Aligning Indication

If the G5 senses the attitude solution is invalid, "ALIGNING KEEP WINGS LEVEL" is displayed. No attitude information is displayed while this indication is shown. The G5 can align itself both while taxiing and during level flight.



Figure 1-5 Attitude Aligning Keep Wings Level Indication

If the G5 inertial sensors fail, "ATTITUDE FAIL" is displayed in addition to a red 'X' over the display. No attitude information is displayed while this indication is shown.



Figure 1-6 Attitude Failure Indication

1.4.1.2 G5 HEADING

The G5 can display magnetic heading information received from the GMU 11 magnetometer. If magnetic heading input data is not available, the G5 will display GPS-derived ground track and the heading field will have a red 'X' displayed.



Figure 1-7 Heading Fail (PFD Page)



Figure 1-8 Heading Fail (HSI Page)

If both magnetic heading and GPS are unavailable, the heading field will have a red 'X' displayed and the compass card will be removed from the HSI.



Figure 1-9 Heading/Track Fail (PFD Page)



Figure 1-10 Heading/Track Fail (HSI Page)

The G5 corrects for shifts and variations in the Earth's magnetic field by applying the Magnetic Field Variation Database. The Magnetic Field Variation Database is derived from the International Geomagnetic Reference Field (IGRF). The IGRF is a mathematical model that describes the Earth's main magnetic field and its annual rate of change. The database is updated approximately every 5 years via a software update. Failure to update this database could lead to erroneous heading information being displayed to the pilot.

If the G5 senses the magnetic heading measurement is valid but possibly outside of the internal accuracy limits, the numeric heading is displayed in yellow.

If the GAD 29B fails, VFR will be displayed in amber text and GPSS will be displayed in amber text, if GPSS mode is selected.



Figure 1-11 GAD 29B Fail (Amber VFR)



Figure 1-12 GAD 29B Fail (Amber GPSS)

1.4.2 BACKLIGHT INTENSITY

When set to Auto, the backlight is automatically adjusted according to ambient light conditions. When set to Manual, the backlight level is set by the pilot.

Adjusting backlight intensity:

- 1) While the unit is turned on, press the Power Button.
- 2) Turn the Selection Knob to adjust the backlight intensity.
- 3) Press the Selection Knob to close the backlight page.

Setting the backlight intensity to automatic:

- 1) While the unit is turned on, press the Power Button.
- 2) Press the Power Button again to select **Auto**.
- 3) Press the Selection Knob to close the backlight page.

1.5 ACCESSING FUNCTIONALITY

1.5.1 PAGES



NOTE: The G5 will automatically return to the PFD Page when the aircraft enters an unusual attitude (if enabled in the system configuration). Refer to the Installation Manual for more information.

The G5 has two main pages, the HSI Page and the PFD Page. The HSI Page can be accessed from the PFD Page (unless it has been disabled in configuration).



Figure 1-13 PFD Page



Figure 1-14 HSI Page

Displaying the HSI page from the PFD page:

- 1) From the PFD Page press the Selection Knob to display the Menu.
- 2) Use the Selection Knob to select HSI.



NOTE: The G5 can be configured to display the PFD or HSI page when power is applied (if allowed by the current system configuration). Refer to the Installation Manual for more information.

1.5.2 MENU

Press the Selection Knob to access the G5 Menu. Navigate the menu by rotating the Selection Knob and make selections by pressing the Selection Knob.



Figure 1-15 PFD Page Menu



Figure 1-16 HSI Page Menu

1.6 MESSAGES

A message [!] indicator appears in the left corner of PFD and HSI Page to alert the pilot of any status messages. The message [!] indicator flashes when there is a new message that has not been viewed.



Figure 1-17 Message [!] Indicator - PFD

Viewing messages on the PFD and MFD Page:

- 1) Press the Selection Knob to display the Menu. The Message Menu Option will appear.
- 2) If necessary, turn the Selection Knob to highlight the **Message** Menu Option.
- 3) Press the Selection Knob to select **Message**. A list of messages is displayed.

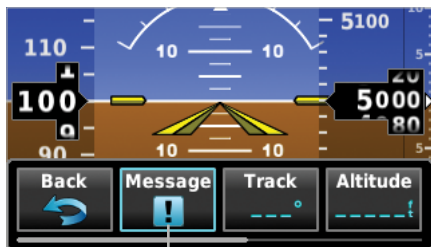

Message [!] Indication Menu Option

Figure 1-18 Message [!] Menu Option (PFD Page)



Message Details

Figure 1-19 Messages [!] Displayed (PFD Page)

1.6.1 SYSTEM MESSAGES

The following table describes G5 system messages that may appear. System messages are displayed in white text.

Table 1-2 System Messages

Message	Meaning
External Power Lost	Aircraft power has been removed from the G5.
Critical battery fault! Powering off	Battery has critical fault condition and the unit is about to power off to avoid damage to the battery.
Battery fault	Battery has a fault condition – unit needs service.
Battery charger fault	Battery charger has a fault condition – unit needs service.
Low battery	Battery charge level is low.
Hardware fault	Unit has a hardware fault – unit needs service.
Power supply fault	Unit power supply fault detected – unit needs service.
Unit temperature limit exceeded	Unit is too hot or too cold.
Network address conflict	Another G5 with the same address is detected on the network (most commonly a wiring error on one of the units).
Communication error	General communication error (most commonly appears in conjunction with Network Address Conflict message).
Factory calibration data invalid	Unit calibration data not valid – unit needs service.
Magnetic field model database out of date	Internal magnetic field database is out of date - software update required.
Magnetometer Hardware fault	The magnetometer has detected a fault – unit needs service. Heading data may not be available.
Using external GPS data	GPS data from another network LRU is being used. The unit's internal GPS receiver is enabled, but unable to establish a GPS fix.

Table 1-2 System Messages

Message	Meaning
Not receiving RS-232 data	The G5 is not receiving RS-232 data from the GPS navigator – system needs service.
Not receiving ARINC 429 data	The G5 is not receiving ARINC 429 data from the navigation source – system needs service.
GPS receiver fault	The G5 on-board GPS receiver has a fault.
ARINC 429 interface configuration error	The G5 ARINC 429 port is receiving information from an incorrect source – system needs service.
Software version mismatch	The G5 attitude indicator and the G5 HSI units have different software. Cross fill of baro, heading and altitude bugs is disabled.

SECTION 2 FLIGHT INSTRUMENTS

2.1 PFD PAGE

The G5 PFD Page displays a horizon, airspeed, attitude, altitude, vertical speed, heading, and course deviation information. The following flight instruments and supplemental flight data are displayed on the PFD Page.

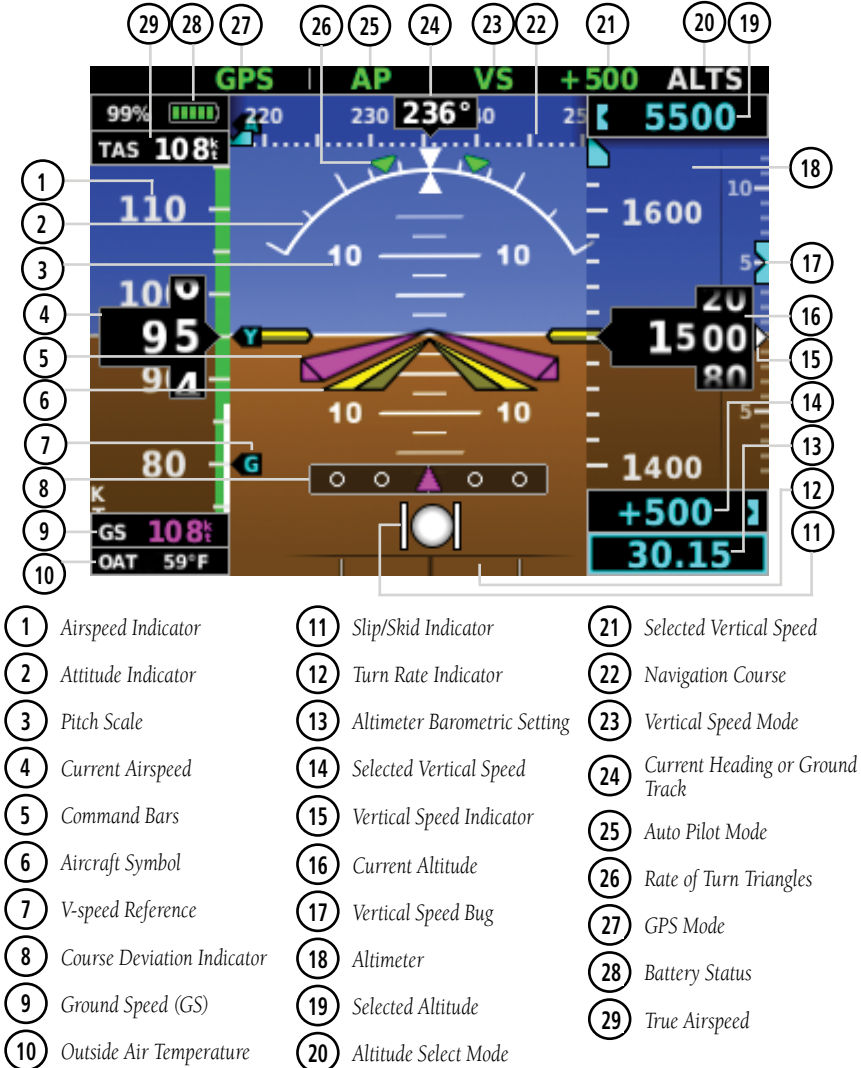

Figure 2-1 G5 PFD Flight Instruments

2.1.1 AIRSPEED INDICATOR



NOTE: The G5 Vspeed Reference values depend upon the aircraft's specific system configuration and may vary from the examples discussed in this section.

The Airspeed Indicator displays airspeed on a rolling number gauge using a moving tape. The numeric labels and major tick marks on the moving tape are marked at intervals of 10 knots. Speed indication starts at 30 knots, with 60 knots of airspeed viewable at any time. The actual airspeed is displayed inside the black pointer. The pointer remains black until reaching never-exceed speed (V_{NE}), at which point it turns red.

A color-coded (red, white, green, yellow, and red/white "barber pole") speed range strip is located on the moving tape. The colors denote flaps operating range, normal operating range, caution range, and never-exceed speed (V_{NE}). A red range is also present for low speed awareness.

The Airspeed Trend Vector is a vertical, magenta line, extending up or down on the airspeed scale, shown to the right of the color-coded speed range strip. The end of the trend vector corresponds to the predicted airspeed in 6 seconds if the current rate of acceleration is maintained. If the trend vector crosses V_{NE} , the text of the actual airspeed display changes to yellow. The trend vector is absent if the speed remains constant or if any data needed to calculate airspeed is not available due to a system failure.

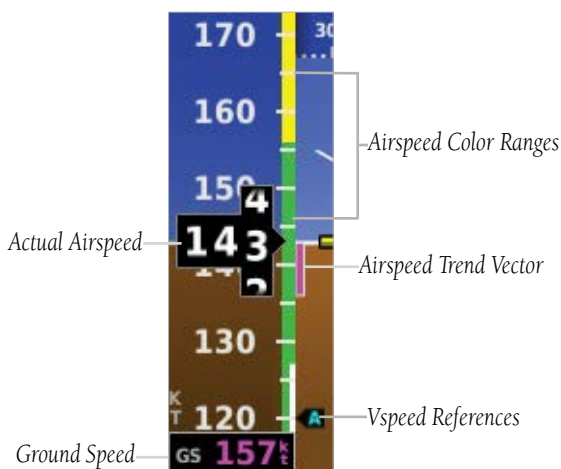

Figure 2-2 Airspeed Indicator

2.1.1.1 VSPEED REFERENCE

When airspeed is present, the configured Vs speeds are displayed at their respective locations to the right of the airspeed scale, otherwise the Vs speeds are displayed at the bottom of the airspeed indicator.

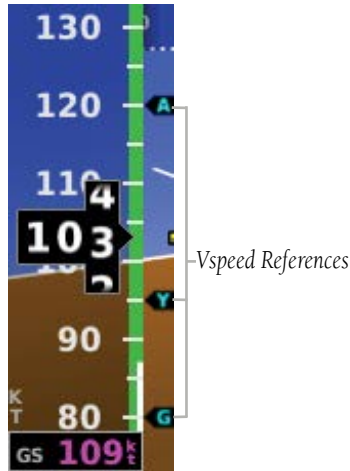

Figure 2-3 Vspeed References

2.1.2 ATTITUDE INDICATOR

Attitude information is displayed over a virtual blue sky and brown ground with a white horizon line. The Attitude Indicator displays the pitch (indicated by the yellow symbolic aircraft on the pitch scale), roll, and slip/skid information.

The horizon line is part of the pitch scale. Pitch markings occur at 2.5° intervals through all pitch ranges. Refer to the Installation Manual to configure the pitch scale.

The inverted white triangle indicates zero on the roll scale. Major tick marks at 30° and 60° and minor tick marks at 10°, 20°, and 45° are shown to the left and right of the zero. Angle of bank is indicated by the position of the pointer on the roll scale.

Slip/skid is indicated by the location of the ball.

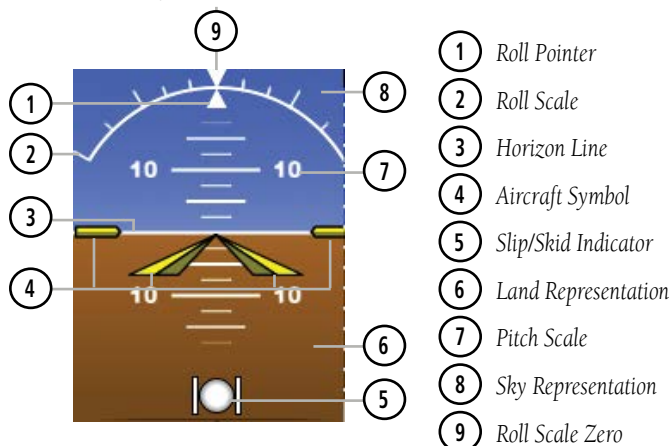

Figure 2-4 Attitude Indicator

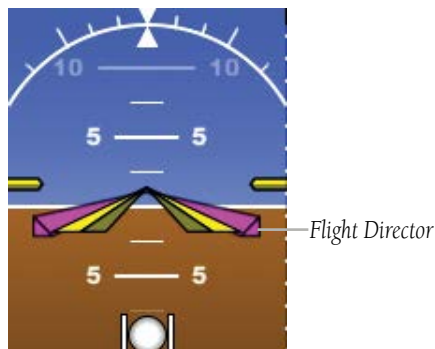

Figure 2-5 Attitude Indicator with Flight Director (Single Cue)

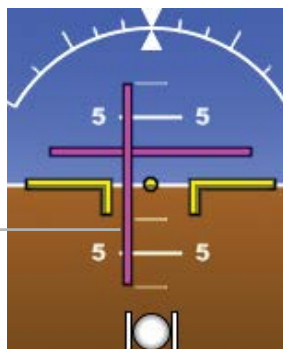

Figure 2-6 Attitude Indicator with Flight Director (Dual Cue)

2.1.2.1 ATTITUDE CONFIGURATION

The roll (bank angle) indication may be configured to be a Ground Pointer (default) or a Sky Pointer. Refer to the G5 Installation Manual for configuration information.

The Ground Pointer configuration displays both the roll arc and the pitch scale anchored to the horizon and the roll pointer beneath the roll arc pointing to the present roll angle.

The Sky Pointer configuration displays the pitch scale moving with the horizon, but the roll arc remains fixed and centered in the display. The roll pointer beneath the roll arc moves with the horizon and in the opposite direction of aircraft roll.

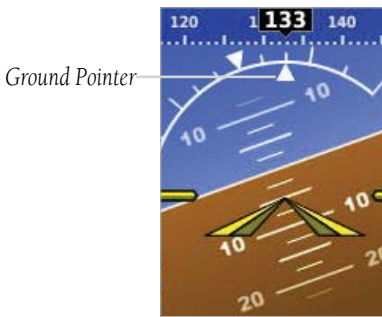

Figure 2-7 Ground Pointer Configuration

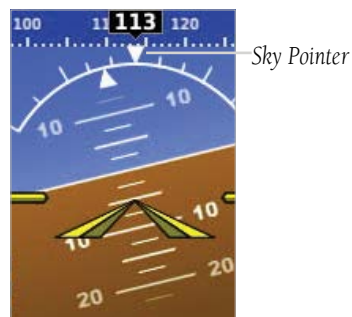

Figure 2-8 Sky Pointer Configuration

2.1.3 ALTIMETER

The Altimeter displays 400 feet of barometric altitude values at a time on a rolling number gauge using a moving tape. Numeric labels and major tick marks are shown at intervals of 100 feet. Minor tick marks are at intervals of 20 feet. The current altitude is displayed in the black pointer.

The Selected Altitude is displayed above the Altimeter in the box indicated by a selection bug symbol. A bug corresponding to this altitude is shown on the tape; if the Selected Altitude exceeds the range shown on the tape, the bug appears at the corresponding edge of the tape.

Setting the selected altitude:

Rotate the **ALT SEL** Knob on the GMC 507.

Or

- 1) Press the Selection Knob to display the Menu.
- 2) Select **Altitude** and use the Selection Knob to change the Selected Altitude.

Syncing to the current altitude:

Press the **ALT SEL** Knob on the GMC 507.

Or

- 1) Press the Selection Knob to display the Menu.
- 2) Select **Altitude** and press and hold the Selection Knob to sync the Selected Altitude to the current altitude.

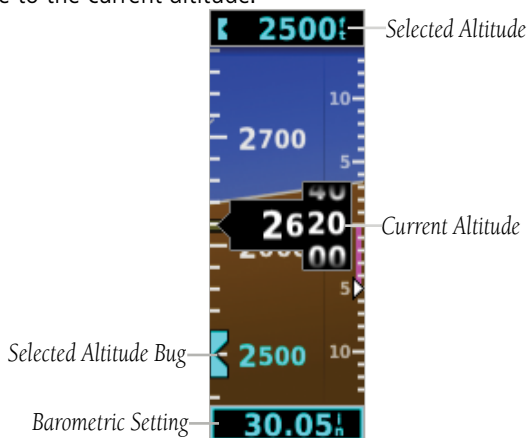

Figure 2-9 Altimeter

2.1.3.1 BAROMETRIC PRESSURE

The barometric pressure setting is displayed below the Altimeter in inches of mercury (Hg), hectopascals (hPa), or millibars (mb) when metric units are selected.

Selecting the altimeter barometric pressure setting:

Turn the Selection Knob to set the barometric pressure.

2.1.3.2 ALTITUDE ALERTING

The Altitude Alerting function provides the pilot with a visual alert and tone (dependant on installation) when approaching the Selected Altitude. Whenever the Selected Altitude is changed, the Altitude Alerter is reset. The following will occur when approaching the Selected Altitude:

- Passing within 1,000 feet of the Selected Altitude, the Selected Altitude (shown above the Altimeter) flashes for 5 seconds.
- When the aircraft passes within 200 feet of the Selected Altitude, the Selected Altitude flashes for 5 seconds to indicate the aircraft is approaching the selected altitude.
- After reaching the Selected Altitude, if the pilot flies outside the deviation band (± 200 Feet of the Selected Altitude), the Selected Altitude changes to yellow text on a black background, flashes for 5 seconds.

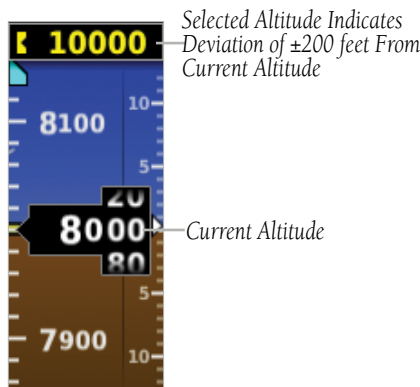

Figure 2-10 Altitude Alerting Visual Annunciation

2.1.4 TURN RATE INDICATOR

The Turn Rate Indicator is located at the bottom of the PFD Page. Tick marks to the left and right of the displayed heading denote standard turn rates (3 deg/sec). A magenta Turn Rate Trend Vector shows the current turn rate. A standard-rate turn is shown on the indicator by the trend vector stopping at the standard turn rate tick mark.



Turn Rate Indicator (Standard Rate Tick Marks)

Figure 2-11 Turn Rate Indicator

2.1.5 HEADING/GROUND TRACK (PFD PAGE)



NOTE: Heading is displayed if magnetometer data is available from a magnetometer via the CAN network. Otherwise, Ground Track is displayed.

A Heading/Ground Track Tape is displayed at the top of the PFD Page and displays numeric labels every 10°. Major tick marks are at 5° intervals and minor tick marks at 1° intervals. The current track is represented by a magenta triangle. The Heading/Ground Track Tape also displays the navigation course.

When displaying the Selected Heading, a cyan bug on the tape corresponds to the Selected Heading. When displaying Ground Track, a magenta bug is displayed on the tape. The heading bug turns hollow when GPSS is selected.

Adjusting the selected heading or ground track:

Use the **HDG** Knob on the GMC 507.

Or

- 1) Press the Selection Knob to display the Menu.
- 2) Select **Heading** or **Track** and use the Selection Knob to change the Selected Heading or Track.

Syncing to the current heading or ground track:

Press the **HDG** Knob on the GMC 507.

Or

- 1) Press the Selection Knob to display the Menu.
- 2) Select **Heading** or **Track** and press and hold the Selection Knob to sync the selected heading or ground track to the current heading or ground track.

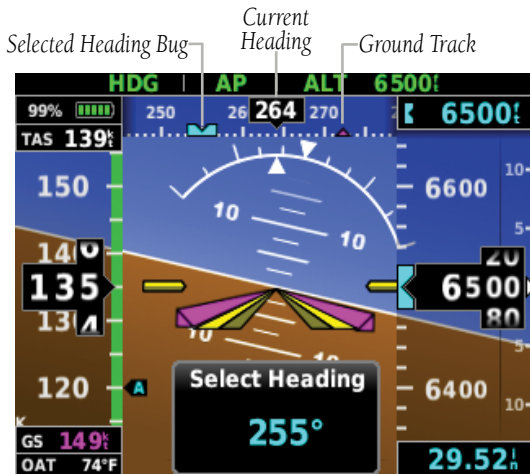

Figure 2-12 PFD Page - Selected Heading



Figure 2-13 PFD Page - Selected Ground Track

2.1.6 VERTICAL SPEED INDICATOR (VSI)

The Vertical Speed Indicator displays the aircraft vertical speed using a non-moving tape with minor tick marks every 100 feet. The current vertical speed is displayed using a white arrow along the tape.

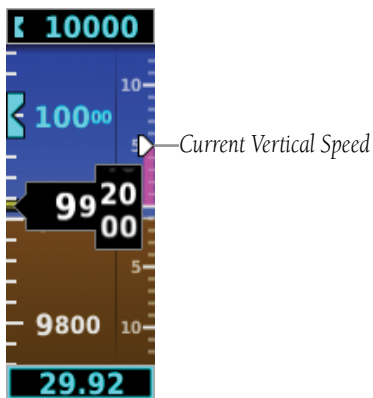





Figure 2-14 Vertical Speed Indicator

2.1.7 BATTERY STATUS INDICATOR

When the G5 is powered by the aircraft electrical bus, the battery status indicator can be displayed by pressing the G5 Power Button. When the G5 is powered by the battery, the battery status indicator is displayed automatically. This indicator shows the estimated percent charge of the battery. After about one minute on battery power, the indicator shows the estimated time (in hours and minutes) until the battery is empty. The current charge level of the battery is indicated by the filled-in portion of the battery icon. The battery icon turns yellow or red to indicate a low-battery condition

3:15 	41%-100%
1:31 	21%-40%
0:38 	0%-20%

The battery is required for the G5 unit installed as an attitude display indicator (ADI) and is optional for the G5 unit installed as a horizontal situation indicator (HSI)

When the G5 is connected to external power and the battery is being charged, a lightning bolt symbol appears over the battery icon.



Other battery indications:



Battery charger hardware fault, or temperature too high/low to safely charge the battery. The system is running on external power but cannot charge the battery.



Battery fault.



Battery is not present (appears only when the battery status field has been configured to always appear).

2.2 HSI PAGE



NOTE: The HSI Page can be configured as disabled in configuration mode.

The G5 HSI Page displays a rotating compass card in a heading-up orientation. Letters indicate the cardinal points and numeric labels occur every 30°. Major tick marks are at 10° intervals and minor tick marks at 5° intervals. The current ground track is represented on the HSI by magenta triangle and a dashed line. The HSI also presents course deviation, bearing, and navigation source information. The following items are displayed on the HSI Page:



- | | | |
|----------------------------|---------------------------------|--------------------------|
| 1 Battery Status Indicator | 6 Heading Bug | 11 Rotating Compass Rose |
| 2 Wind Speed and Direction | 7 Bearing Pointer | 12 Current Heading |
| 3 Navigation Source | 8 Desired Track | 13 Distance To Waypoint |
| 4 Aircraft Symbol | 9 Selected Heading/Ground Track | |
| 5 GPS CDI Scale | 10 Bearing Pointer | |

Figure 2-15 Horizontal Situation Indicator (HSI) - Normal

Table 2-1 Annunciations

③ Nav Source Annunciations				⑪ GPS CDI Scale Annunciations		
GPS/ GPS1/ GPS2	VLOC/	VOR/	LOC/	LP	LPV	LNAV
	VLOC1/	VOR1/	LOC1/	LNAV/VNAV	LNAV+V	APR
	VLOC2	VOR2	LOC2	TERM	ENR	OCN
				VFR (0.25nm, 1.25nm, 5.00nm)		
⑤ Navigator Messages Annunciations						
LOI	Loss of GPS Integrity			MSG	Pending Nav Message	
DR	GPS Dead-Reckoning Mode			WPT	Waypoint Arrival	



NOTE: The VFR CDI Scale is displayed when the G5 is connected to a GPS navigator via RS-232 only, or if ARINC 429 GPS navigation data is unavailable.

2.2.1 HORIZONTAL SITUATION INDICATOR (HSI)

The Horizontal Situation Indicator (HSI) on the HSI Page displays a rotating compass card in a heading-up orientation. Letters indicate the cardinal points and numeric labels occur every 30°. Major tick marks are at 10° intervals and minor tick marks at 5° intervals. The current track is represented on the HSI by magenta triangle and a dashed line. The HSI also presents course deviation, bearing, and navigation source information.



- | | | |
|----------------------------|---------------------------------|------------------------|
| ① Wind Speed and Direction | ⑤ GPS CDI Scale | ⑨ Aircraft Symbol |
| ② Heading Bug | ⑥ Desired Track | ⑩ Bearing Pointer |
| ③ Bearing Pointer | ⑦ Selected Heading/Ground Track | ⑪ Current Heading |
| ④ Navigation Source | ⑧ Rotating Compass Rose | ⑫ Distance To Waypoint |

Figure 2-16 Horizontal Situation Indicator (HSI) - Expanded

Displaying the HSI page from the PFD page:

- 1) From the PFD Page press the Selection Knob to display the Menu.
- 2) Select HSI.

2.2.1.1 BEARING POINTERS

One or two bearing pointers can be displayed on the HSI for NAV (VOR) and GPS sources. The bearing pointers are cyan. The bearing pointers never override the CDI and are visually separated from the CDI by a white ring (shown when the bearing pointers are selected but not necessarily visible due to data unavailability). If there are two navigation inputs configured, two bearing pointers will be displayed.



Figure 2-17 GPS Source Bearing Pointer

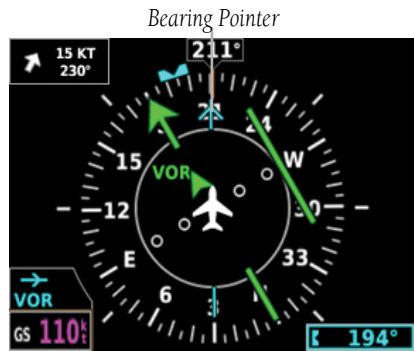

Figure 2-18 VOR Source Bearing Pointer

Enabling/disabling the bearing pointer(s):

- 1) From the HSI Page, press the Selection Knob to display the Menu.
- 2) Turn the Selection Knob to highlight **Setup**.
- 3) Press the Selection Knob and turn to highlight the **Bearing Pointer 1** setting.



Figure 2-19 Setup Menu



Figure 2-20 Bearing Pointer Setting

- 4) Press the Selection Knob and turn to select bearing pointer source (**None**, **GPS**, **VLOC**).
- 5) Repeat steps 1-4 to enable/disable the **Bearing Pointer 2** setting.



Figure 2-21 Bearing Pointer Source Options

2.2.2 HEADING/GROUND TRACK (HSI PAGE)

The Selected Heading or Ground Track is shown to the right of the HSI. The cyan bug (heading) or magenta bug (ground track) on the compass rose corresponds to the Selected Heading or Ground Track.



NOTE: Heading is displayed if magnetometer data is available from a magnetometer via the CAN network. Otherwise, Ground Track is displayed.

Adjusting the selected heading or ground track from the HSI page:

Use the **HDG** Knob on the GMC 507.

Or

From the HSI Page, turn the Selection Knob to adjust the selected heading or ground track.

Syncing to the current heading or ground track from the HSI page:

Press the **HDG** Knob on the GMC 507.

Or

From the HSI Page, press and hold the Selection Knob to sync to the current heading or ground track.

2.3 NAVIGATION

When properly configured, the G5 can display data from either the #1 or #2 navigation source. If the navigation source is a GNS/GTN unit, both GPS and VLOC data can be displayed

2.3.1 COURSE DEVIATION INDICATOR (CDI)

The PFD Page displays the Course Deviation Indicator (CDI) below the slip/skid indicator. The HSI Page displays the CDI on the Horizontal Situation Indicator.

The Course Deviation Indicator (CDI) move left or right along a lateral deviation scale to display the aircraft position relative to the course. If the course deviation data is not valid, the CDI is not displayed.

The CDI is capable of displaying multiple sources of navigation (GPS, VLOC, or both) depending on the external navigator(s) configured (refer to the G5 Installation Manual for more information). Color indicates the current navigation source: magenta (for GPS) or green (for VOR and LOC). The full-scale limits for the CDI are defined by a GPS-derived distance when coupled to GPS. When coupled to a VOR or localizer (LOC), the CDI has the same angular limits as a mechanical CDI.



Figure 2-22 Course Deviation Indicator - PFD



Course Deviation Indicator

Figure 2-23 Course Deviation Indicator - HSI

Changing the navigation source (GPS, VOR, LOC, or VLOC):

Use either the #1 or #2 external navigator to toggle between GPS and VOR/LOC source types.

2.3.2 VERTICAL DEVIATION (GLIDESLOPE) INDICATOR - ILS SOURCE

The Vertical Deviation (Glideslope) Indicator (VDI) appears to the left of the altimeter (PFD page) and to the right of the compass rose (HSI page) whenever an ILS frequency is tuned in the active NAV field of an external navigator. A green diamond acts as the VDI, like a glideslope needle on a conventional indicator. If a localizer frequency is tuned and there is no glideslope signal, "NO GS" is annunciated.



Vertical Deviation Indicator

Figure 2-24 Vertical Deviation Indicator (Glideslope ILS Source) - PFD



Figure 2-25 Vertical Deviation Indicator (Glideslope ILS Source) - HSI

2.3.3 VERTICAL DEVIATION (GLIDEPATH) INDICATOR - GPS SOURCE

The Vertical Deviation (Glidepath) Indicator (VDI) also appears to the left of the altimeter (PFD page) and to the right of the compass rose (HSI page) during a GPS approach. The glidepath is analogous to the glideslope for GPS approaches supporting WAAS vertical guidance (LNAV+V, L/VNAV, LPV). The Glidepath Indicator appears on the G5 as a magenta diamond. If the approach type downgrades past the final approach fix (FAF), "NO GP" is annunciated.



Vertical Deviation Source
Vertical Deviation Indicator

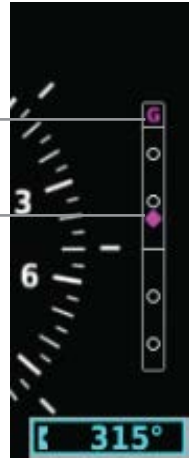

Figure 2-26 Vertical Deviation Indicator (Glidepath GPS Source) - PFD

Figure 2-27 Vertical Deviation Indicator Position - HSI

2.3.4 VNAV INDICATOR

The magenta chevron (VNAV Indicator) to the left of the altimeter on the Vertical Deviation Scale displays the VNAV profile.

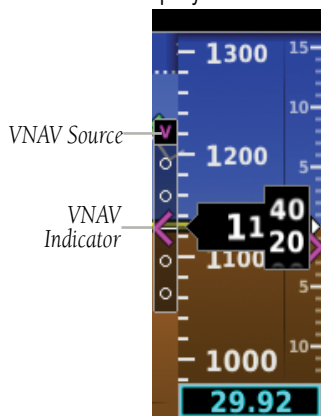

Figure 2-28 VNAV Indicator - PFD

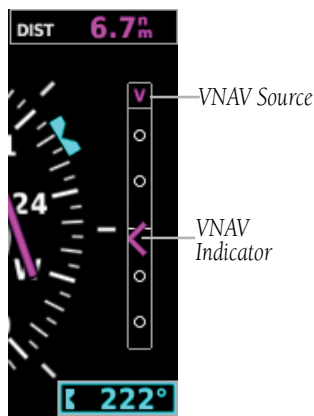

Figure 2-29 VNAV Indicator - HSI

2.3.5 COURSE SELECTION (OPTIONAL)

When the G5 is receiving VOR or LOC data, a **Course** menu option is displayed.

Setting the course for a VOR or localizer:

- 1) From the HSI Page, press the Selection Knob to display the Menu.
- 2) Select **Course** and use the Selection Knob to adjust the course.



Figure 2-30 Course - HSI

When OBS is activated on the navigator, an OBS menu option is displayed.

Setting the OBS:

- 1) From the HSI Page, press the Selection Knob to display the Menu.
- 2) Select **OBS** and use the Selection Knob to adjust the course.



Figure 2-31 OBS - HSI

Blank Page

SECTION 3 AUTOMATIC FLIGHT CONTROL SYSTEM (OPTIONAL)



NOTE: The approved aircraft documentation always supersedes the information in this Pilot's Guide.



NOTE: Refer to the approved aircraft documentation for emergency procedures.



NOTE: A GMC 507 controller is required for GFC 500 AFCS functionality.

3.1 GFC 500 AFCS CONFIGURATION

The following figure provides an overview of the GFC 500 system:



Figure 3-1 Core GFC 500 System

In addition to the core autopilot functions, the GFC 500 incorporates an independent monitor that uses independent inertial sensors to determine what is happening to the aircraft. By monitoring aircraft attitude, attitude rate and accelerations using these independent sensors, the monitor can shut down the autopilot if it determines the aircraft has exceeded predetermined limits.

The minimum configuration for the GFC 500 system is a G5 configured as an Attitude Indicator and two GSA 28 servos (in the pitch and roll positions). This will provide Pitch, Roll, Track, and Air Data modes only.

If navigation modes are desired, a G5 connected to a compatible navigation source (e.g., a GTN 6XX/7XX) is an option.

The basic GFC 500 system is comprised of the following equipment:

3.1.1 GMC 507 MODE CONTROLLER

The panel-mounted GMC 507 serves as the primary user interface for the GFC 500. The GMC 507 provides autopilot and flight director mode selection keys and a wheel for convenient adjustment of the pitch, airspeed, and vertical speed references. The G5 PFD Page displays active and armed modes and reference values.



Figure 3-2 GMC 507

3.1.2 GSA 28 SERVO

The GSA 28 servos provide control surface actuation as part of the autopilot, yaw damper, electric trim, and ESP functions. The GSA 28 is a 'smart' servo which performs most of the autopilot processing functions and offers many inherent safety features. The brushless motor and electronic torque and speed sensing capabilities provide smooth, reliable operation. The GSA 28 design incorporates an internal engagement

solenoid and a gear train that allows the motor to be backdriven by the pilot in case the solenoid fails to disengage. This eliminates the need for a mechanical slip clutch along with the associated performance limitations and maintenance requirements.



Figure 3-3 GSA 28



NOTE: Refer to the G5 Installation Manual for information on installing and configuring the G5 Integrated Autopilot Interface.

3.2 AFCS SYSTEM ARCHITECTURE

An Automatic Flight Control System (AFCS) is typically comprised of two major components: A flight director (FD) and autopilot servos. The flight director provides pitch and roll commands to the autopilot servos. These pitch and roll commands are displayed on the PFD Page as Command Bars. When the flight director is active the pitch and roll commands can be hand-flown by the pilot or when coupled with the autopilot, the autopilot servos drive the flight controls to follow the commands issued by the flight director. The flight director operates independently of the autopilot servos, but in most cases the autopilot servos can not operate independent of the flight director.

3.2.1 AUTOPILOT AND YAW DAMPER OPERATION

The autopilot and optional yaw damper operate the flight control surface servos to provide automatic flight control. The autopilot controls the aircraft pitch and roll attitudes following commands received from the flight director. Pitch, Roll, and Yaw (if installed) autotrim provides trim commands to each servo to relieve any sustained effort required by the servo(s). Autopilot operation is independent of the optional yaw damper.

The optional yaw damper reduces Dutch roll tendencies, coordinates turns, and provides a steady force to maintain directional trim. It can operate independently of the autopilot and may be used during normal hand-flight maneuvers. Yaw rate commands are limited to 6 deg/sec by the yaw damper.

3.2.2 FLIGHT CONTROL

Pitch and roll commands are provided to the servos based on the active flight director modes. Yaw commands are provided by the yaw servo. Servo motor control limits the maximum servo speed and torque. This allows the servos to be overridden in case of an emergency.

3.2.3 PITCH AXIS AND TRIM

The autopilot pitch axis uses pitch rate to stabilize the aircraft pitch attitude during flight director maneuvers. Flight director pitch commands are rate and attitude-limited, combined with pitch damper control, and sent to the pitch servo motor. The pitch servo measures the output effort (torque) and optionally provides this signal to the pitch trim motor. The pitch servo commands the pitch trim motor to reduce the average pitch servo effort.

3.2.4 ROLL AXIS

The autopilot roll axis uses roll rate to stabilize aircraft roll attitude during flight director maneuvers. The flight director roll commands are rate- and attitude-limited, combined with roll damper control, and sent to the roll servo motor.

3.2.5 YAW AXIS

The yaw damper uses yaw rate and roll attitude to dampen the aircraft's natural Dutch roll response. It also uses lateral acceleration to coordinate turns and reduce or eliminate the need for the pilot to use rudder pedal force to maintain coordinated flight during climbs and descents.

3.2.6 G5 AFCS STATUS BOX

The AFCS status box displays autopilot (AP) and flight director (FD) mode annunciations on the PFD Page.

Autopilot (AP) status is displayed middle of the G5 Autopilot Status Box. Lateral modes are displayed on the left, and vertical modes are displayed on the right. Armed modes are displayed in white and active in green.

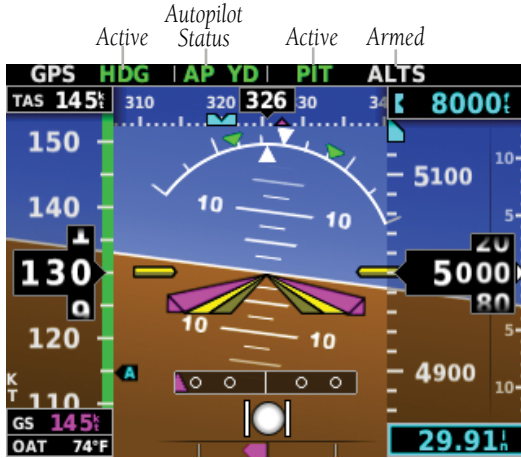

Figure 3-4 Autopilot Status Box

3.3 AFCS OPERATION

The AFCS provides the following main operating functions:

- Flight Director (FD)** — The flight director function provides pitch and roll commands needed to guide the aircraft toward the active reference selected by the pilot. These pitch and rolls commands are displayed on the G5 PFD Page as Command Bars. When the flight director is active the pitch and roll commands can be hand-flown by the pilot. When the autopilot is engaged the autopilot servos drive the flight controls to follow the commands issued by the flight director.
- Autopilot (AP)** — The autopilot function is provided by servo actuators which move the flight control surfaces in response to flight director steering commands, aircraft attitude, and airspeed. The optional pitch auto-trim function serves to relieve any sustained effort required by the pitch servo to keep the aircraft in trim.

- Yaw Damper (YD)** — The optional Yaw Damper function provides Dutch Roll damping, assists in turn coordination, and provides a steady force to help maintain directional trim. If installed the YD comes on when the autopilot is engaged. It can be turned on/off independent of the autopilot and may be used during normal hand-flying maneuvers.
- Manual Electric Trim (MET)** — The optional Manual Electric Trim uses the same servo as the auto-trim function and allows the pilot to command trim via a trim switch when the autopilot is not engaged. The MET function does not preclude the use of the aircraft’s basic mechanical trim system.
- Electronic Stability & Protection (ESP) (GFC 500)** — The ESP function provides a soft barrier to keep the aircraft within the desired operating envelope when the autopilot is not engaged. When the AFCS senses that the aircraft is near the defined operating limit in pitch attitude, roll attitude, high airspeed, or low airspeed, the ESP function will automatically engage one or more servos to nudge it back to the nominal operating envelope. While ESP utilizes the same sensors, processors, and actuators as the AFCS autopilot it is a separate mutually exclusive function. ESP can be easily overpowered by the pilot and can be disabled using the **AP DISC / TRIM INT** Button.

3.3.1 GMC 507 CONTROLS

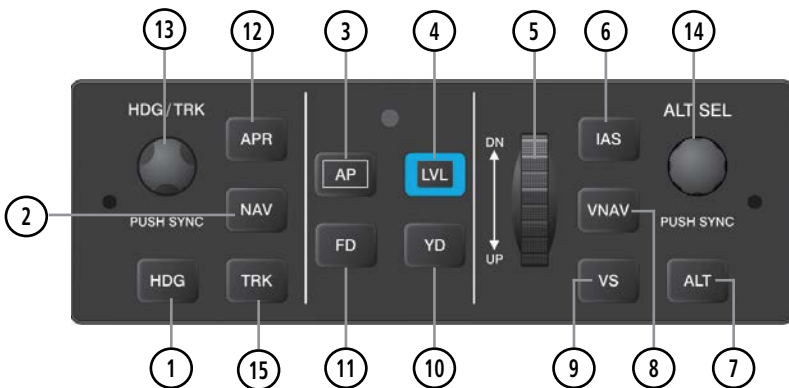

Figure 3-5 GMC 507 AFCS Control Unit

Table 3-2 AFCS Controls

- ① **HDG Key** Selects/deselects Heading Select Mode. (No function in installations without a magnetometer)
- ② **NAV Key** Selects/deselects Navigation Mode. Cancels GS Mode if LOC Mode is either active or armed. Cancels GP Mode if GPS Mode is either active or armed. Cancels LOC Mode if GPS Mode is active and LOC Mode is armed.
- ③ **AP Key** Engages/disengages the autopilot
- ④ **LVL (Level) Key** Engages the autopilot (if the autopilot is disengaged) in level vertical and lateral modes
- ⑤ **NOSE UP/DN Wheel** Adjusts the vertical mode reference in Pitch Hold, Vertical Speed, Indicated Airspeed, and Altitude Hold modes
- ⑥ **IAS Key** Selects/deselects Indicated Airspeed Mode
- ⑦ **ALT Key** Selects/deselects Altitude Hold Mode
- ⑧ **VNAV Key** Selects/deselects Vertical Path Tracking Mode for Vertical Navigation flight control
- ⑨ **VS Key** Selects/deselects Vertical Speed Mode
- ⑩ **YD Key** Engages/disengages the yaw damper
- ⑪ **FD Key** Activates/deactivates the flight director only
Pressing once turns on the director in the default vertical and lateral modes. Pressing again deactivates the flight director and removes the Command Bars. If the autopilot is engaged, the key is disabled.
- ⑫ **APR Key** Selects/deselects Approach Mode (GP or GS mode only)
- ⑬ **HDG/TRK Knob** Selects the desired Heading/Track
- ⑭ **ALT SEL Knob** Selects the desired Altitude setting
- ⑮ **TRK Key** Selects/deselects Track (TRK) Mode.

The following AFCS controls are located separately from the G5 and GMC 507 AFCS Control Unit:

Table 3-3 Other AFCS Controls

Control	Action
AP DISC / TRIM INT (Autopilot Disconnect)	An AP DISC / TRIM INT Button is located on the pilot's control stick. Press and release the AP DISC / TRIM INT Button to disengage the autopilot.
Go Around Button (Takeoff/Go Around)	Selects flight director Takeoff or Go Around Mode.
MET Switch (Optional) (Manual Electric Trim)	Used to command manual electric pitch trim.

3.3.1.1 ENGAGING THE AUTOPILOT

ENGAGING THE AUTOPILOT:

An initial press of the **AP** Key on the GMC 507 will activate the flight director and engage the autopilot in the default PIT and ROL modes.

3.3.1.2 DISENGAGING THE AUTOPILOT

The autopilot is manually disengaged by pressing the autopilot disconnect button on the control stick or yoke or by pressing the **AP** Key on the GMC 507. Manual disengagement is indicated by a five-second flashing yellow 'AP' annunciation. Cancel the aural alert by pressing and releasing the **AP** Key again.

In addition, the optional **MET** trim switch will disengage the autopilot.

Automatic disengagement is indicated by a flashing red 'AP' annunciation. Automatic disengagement occurs due to:

- System failure
- Invalid sensor data
- Inability to compute default autopilot modes
- Autopilot internal monitoring detects abnormal behavior

3.3.1.3 OVERPOWERING AUTOPILOT SERVOS

In the context of this discussion, "overpowering" refers to any pressure or force applied to the pitch controls when the autopilot is engaged. A small amount of pressure or force on the pitch controls can cause the autopilot automatic trim to run to an out-of-trim condition. Therefore, any application of pressure or force to the controls should be avoided when the autopilot is engaged.

Overpowering the autopilot during flight will cause the autopilot's automatic trim to run, resulting in an out-of-trim condition or cause the trim to hit the stop if the action is prolonged. In this case, larger than anticipated control forces may be required after the autopilot is disengaged.

The following steps should be added to the preflight check:

- 1) Check for proper autopilot operation and ensure the autopilot can be overpowered.
- 2) Note the forces required to overpower the autopilot servo clutches.

3.3.2 FLIGHT DIRECTOR OPERATION



NOTE: Refer to the Installation Manual for AFCS setup information.

The flight director function provides pitch and roll commands to the pilot and autopilot, which are displayed on the PFD Page. With the flight director active, the aircraft can be hand-flown to follow the path shown by the Command Bars. The flight director has the following maximum commands: pitch (-15°, +20°) and roll (30°) angles.

3.3.2.1 ACTIVATING THE FLIGHT DIRECTOR

An initial press of a key listed in the table below (when the flight director is not active) activates the flight director in the listed modes. The flight director may be turned off and the Command Bars removed from the display by pressing the **FD** Key again. The **FD** Key is disabled when the autopilot is engaged.

Table 3-4 Flight Director Activation (GMC 507)

Control Pressed	Modes Selected			
	Lateral		Vertical	
FD Key	Roll Hold (default)	ROL	Pitch Hold (default)	PIT
AP Key	Roll Hold (default)	ROL	Pitch Hold (default)	PIT
GA Button	Takeoff (on-ground)	TO	Takeoff (on-ground)	TO
	Go Around (in-air)	GA	Go Around (in-air)	GA
ALT Key	Roll Hold (default)	ROL	Altitude Hold	ALT
VS Key	Roll Hold (default)	ROL	Vertical Speed	VS
VNAV Key	Roll Hold (default)	ROL	Vertical Navigation*	VNAV
IAS Key	Roll Hold (default)	ROL	Indicated Airspeed	IAS
APR Key	Approach**	GPS/VOR/ LOC/ILS	Pitch Hold (default)	PIT
NAV Key	Navigation**	GPS/VOR/ LOC	Pitch Hold (default)	PIT
HDG Key	Heading Select	HDG	Pitch Hold (default)	PIT
TRK Key	Track Select	TRK	Pitch Hold (default)	PIT
LVL Key	Level Hold	LVL	Level Hold	LVL

*Must be receiving VNAV data from a GPS navigator.

**The selected navigation receiver must have an active GPS course before NAV or APR Key press activates flight director.

3.3.2.2 FLIGHT DIRECTOR MODES

Flight director modes are normally selected independently for the pitch and roll axes. Unless otherwise specified, all mode keys are alternate action (i.e., press on, press off). In the absence of specific mode selection, the flight director reverts to the default pitch and/or roll modes.

Armed modes are annunciated in white and active in green in the AFCS Status Box. Under normal operation, when the control for the active flight director mode is pressed, the flight director reverts to the default mode(s) for the axis(es). Automatic transition from armed to active mode is indicated by the white armed mode annunciation moving to the green active mode field and flashing for 10 seconds.

If the information required to compute a flight director mode becomes invalid or unavailable, the flight director automatically reverts to the default mode for that axis. A flashing yellow mode annunciation and annunciator light indicate loss of sensor or navigation data required to compute commands. When such a loss occurs, the system automatically begins to roll the wings level (enters Roll Hold Mode) or maintain the pitch angle (enters Pitch Hold Mode), depending on the affected axis. The flashing annunciation stops when the affected mode key is pressed or another mode for the axis is selected. If after 10 seconds no action is taken, the flashing annunciation stops. The flight director is automatically disabled if the attitude information required to compute the default flight director modes becomes invalid or unavailable.

3.3.2.3 COMMAND BARS

Upon activation of the flight director, Command Bars are displayed in magenta on the PFD Page. If the aircraft is being flown by hand, the command bars are displayed hollow. The Command Bars do not override the Aircraft Symbol. The Command Bars move together vertically to indicate pitch commands and bank left or right to indicate roll commands.

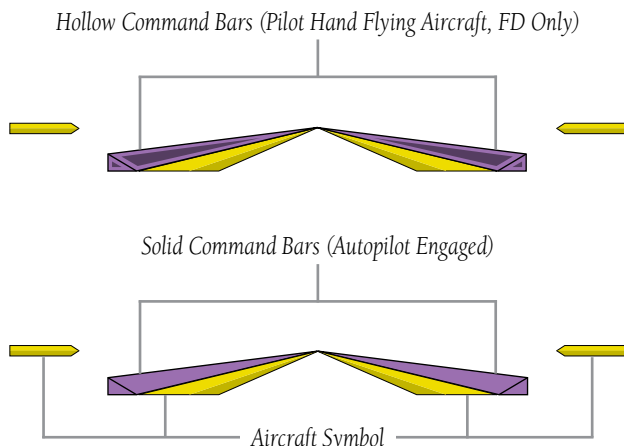

Figure 3-6 Command Bars (Single Cue Flight Director)

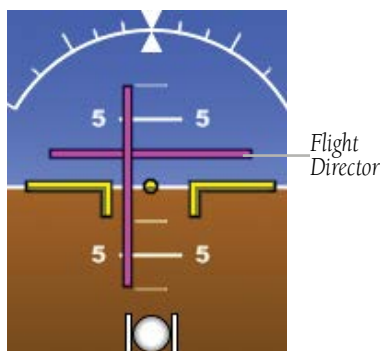

Figure 3-7 Flight Director (Dual Cue)

If the attitude information being sent to the flight director becomes invalid or unavailable, the Command Bars are removed from the display.

3.3.3 VERTICAL MODES

The table lists the vertical modes with their corresponding controls and annunciations. The mode reference is displayed next to the active mode annunciation for Altitude Hold, Vertical Speed, and Indicated Airspeed modes. The **NOSE UP/DN** Wheel can be used to change the vertical mode reference while operating under Pitch Hold, Vertical Speed, Indicated Airspeed, or Altitude Hold modes. Increments of change of values for each of these references using the **NOSE UP/DN** Wheel, are also listed in the table.

Table 3-5 Flight Director Vertical Modes

Vertical Mode	Description	Control	Annunciation	Reference Change Increment
Pitch Hold	Holds the current aircraft pitch attitude; may be used to climb/descend to the Selected Altitude	(default)	PIT	0.5°
Selected Altitude Capture	Captures the Selected Altitude	*	ALTS	10 ft
Altitude Hold	Holds the current Altitude	ALT Key	ALT	
Vertical Speed	Maintains the current aircraft vertical speed; may be used to climb/descend to the Selected Altitude	VS Key	VS	100 fpm
Indicated Airspeed (IAS)	Maintains the current aircraft airspeed in IAS while the aircraft is climbing/descending to the Selected Altitude	IAS Key	IAS	1 kt

Table 3-5 Flight Director Vertical Modes

Vertical Mode	Description	Control	Annunciation	Reference Change Increment
Vertical Navigation	Captures and tracks descent legs of an active vertical profile	VNAV Key	VNAV	
Glidepath	Captures and tracks the GPS WAAS glidepath on approach	APR Key	GP	
Glideslope	Captures and tracks the ILS glideslope on approach		GS	
Takeoff	Commands a constant pitch angle and wings level on-ground in preparation for takeoff	GA Button	TO	
Go Around	Commands a constant pitch angle and wings level in the air		GA	

* ALTS armed automatically when PIT, VS, IAS, TO, or GA active, and under VNAV when Selected Altitude is to be captured instead of VNAV Target Altitude

3.3.3.1 PITCH HOLD MODE (PIT)

When the flight director is activated (**FD** Key pressed) or when the autopilot is activated, Pitch Hold Mode is selected by default. Pitch Hold Mode is indicated as the active vertical mode by the green 'PIT' annunciation. This mode may be used for climb or descent to the Selected Altitude (shown above the Altimeter), since Selected Altitude Capture Mode is automatically armed when Pitch Hold Mode is activated.

In Pitch Hold Mode, the flight director maintains a constant pitch attitude. The pitch reference is set to the aircraft pitch attitude at the moment of mode selection. If the aircraft pitch attitude exceeds the flight director pitch command limitations, the flight director commands a pitch angle equal to the nose-up/down limit.

Changing the pitch reference:

When operating in Pitch Hold Mode, the pitch reference can be adjusted by using the **NOSE UP/DN** Wheel.



Figure 3-8 Pitch Hold & Selected Altitude Capture Modes

3.3.3.2 SELECTED ALTITUDE CAPTURE MODE (ALTS)

Selected Altitude Capture Mode is automatically armed with activation of the following modes:

- Pitch Hold
- Vertical Speed
- Indicated Airspeed
- TO/Go Around
- Vertical Path Tracking

The white 'ALTS' annunciation indicates Selected Altitude Capture Mode is armed.



Figure 3-9 Selected Altitude Capture Mode (Armed)

As the aircraft nears the Selected Altitude, the flight director automatically transitions to Selected Altitude Capture Mode with Altitude Hold Mode armed. This automatic transition is indicated by the green 'ALTS' annunciation flashing for up to 10 seconds and the appearance of the white 'ALTS' annunciation.

At 50 feet from the Selected Altitude, the flight director automatically transitions from Selected Altitude Capture to Altitude Hold Mode and holds the reference altitude. As Altitude Hold Mode becomes active, the white 'ALTS' annunciation moves to the active vertical mode field and flashes green for 10 seconds to indicate the automatic transition.

Setting the selected altitude:

Use the **ALT SEL** Knob on the GMC 507 to adjust the selected altitude.

Or

- 1) Press the Selection Knob to display the Menu.
- 2) Select **Altitude** and use the Selection Knob to change the Selected Altitude.

Syncing to the current altitude:

Press the **ALT SEL** Knob on the GMC 507.

Or

- 1) Press the Selection Knob to display the Menu.
- 2) Select **Altitude** and press and hold the Selection Knob to sync the Selected Altitude to the current altitude

Changing the Selected Altitude while Selected Altitude Capture Mode is active causes the autopilot to revert to Pitch Hold Mode with Selected Altitude Capture Mode armed for the new Selected Altitude.

3.3.3.3 ALTITUDE HOLD MODE (ALT)

Altitude Hold Mode can be activated by pressing the **ALT** Key; the AFCS maintains the current aircraft altitude (to the nearest 10 feet) as the Altitude Reference. Altitude Hold Mode active is indicated by a green 'ALT' annunciation in the G5 Autopilot Status Box.

Altitude Hold Mode is automatically armed when in Selected Altitude Capture Mode. Selected Altitude Capture Mode automatically transitions to Altitude Hold Mode when within 50 feet of the Selected Altitude. In this case, the Selected Altitude becomes the Altitude Reference.

3.3.3.3.1 CHANGING THE ALTITUDE REFERENCE

When operating in Altitude Hold Mode, the Altitude Reference can be adjusted in the following ways:

- The Altitude Reference can be adjusted up or down in 10-foot increments by rolling the **NOSE UP/DN** Wheel. Using this method, up to 200 feet of altitude change can be commanded. To change the Altitude Reference by more the 200 feet, use another vertical mode (PIT, VS) to capture the desired Selected Altitude.



Figure 3-10 Altitude Hold Mode

3.3.3.4 VERTICAL SPEED MODE (VS)

In Vertical Speed Mode, the flight director acquires and maintains a Vertical Speed Reference. Current aircraft vertical speed (to the nearest 100 fpm) becomes the Vertical Speed Reference at the moment of Vertical Speed Mode activation. This mode may be used for climb or descent to the Selected Altitude (shown above the Altimeter) since Selected Altitude Capture Mode is automatically armed when Vertical Speed Mode is selected.

When Vertical Speed Mode is activated by pressing the **VS** Key, 'VS' is annunciated in green in the Autopilot Status Box. The Vertical Speed Reference is also displayed below the Vertical Speed Indicator. A Vertical Speed Reference Bug corresponding to the Vertical Speed Reference is shown on the indicator.

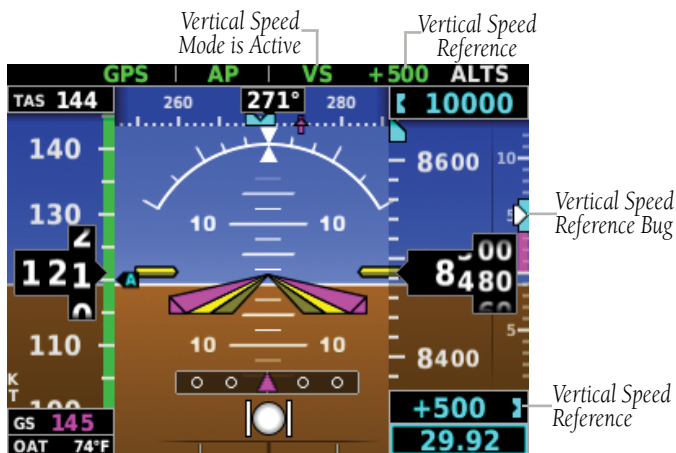

Figure 3-11 Vertical Speed Reference on PFD Page

3.3.3.4.1 CHANGING THE VERTICAL SPEED REFERENCE

Use the **NOSE UP/DN** Wheel to adjust the Vertical Speed Reference in increments of 100 fpm.



Figure 3-12 Vertical Speed Mode

3.3.3.5 INDICATED AIRSPEED MODE (IAS)

Indicated Airspeed Mode is selected by pressing the **IAS** Key on the GMC 507. This mode acquires and maintains the Airspeed Reference (IAS) while climbing or descending. When Indicated Airspeed Mode is active, the flight director continuously monitors Selected Altitude, airspeed and altitude.

The Airspeed Reference is set to the current airspeed upon mode activation. Indicated Airspeed Mode is indicated by a green 'IAS' annunciation in the Autopilot Status Box. The Airspeed Reference is also displayed as a cyan bug corresponding to the Airspeed Reference along the airspeed tape.

Engine power must be adjusted to allow the autopilot to fly the aircraft at a pitch attitude corresponding to the desired flight profile (climb or descent) while maintaining the Airspeed Reference.

3.3.3.5.1 CHANGING THE AIRSPEED REFERENCE

The Airspeed Reference (shown in both the Autopilot Status Box and above the Airspeed Indicator) may be adjusted by using the **NOSE UP/DN** Wheel.

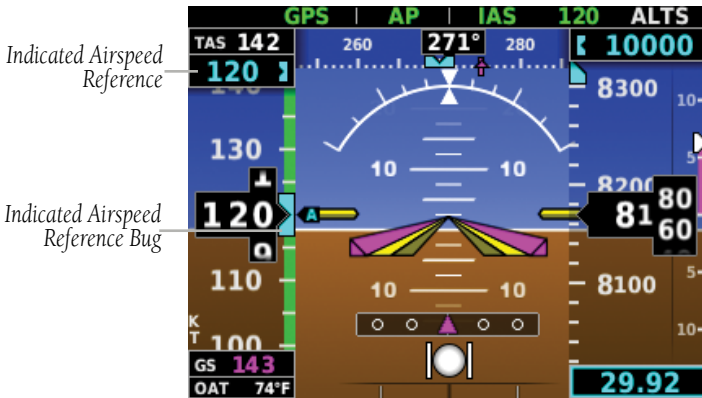

Figure 3-13 Indicated Airspeed Reference on PFD Page

3.3.3.6 VERTICAL NAVIGATION MODE (VNAV)



NOTE: If another vertical mode is touched while VNAV Mode is selected, VNAV Mode reverts to armed.



NOTE: VNAV mode will not capture a descending profile unless the selected altitude is valid and at least 75 feet below the current aircraft altitude.

Vertical Navigation (VNAV) Mode is available for enroute/terminal cruise and descent operations any time that VNAV input data is being received.



Figure 3-14 Vertical Navigation Mode

Activating vertical navigation mode:

- 1) When a flight plan is active, VNAV data is valid, and the **VNAV** Key is selected, VNAV mode is armed in preparation for descent path capture. 'VNAV' is annunciated in white in the G5 Autopilot Status Box.
- 2) When a descent leg is captured (i.e., vertical deviation becomes valid), VNAV Mode is activated and tracks the descent profile.
- 3) Level off when approaching the Selected Altitude.

If the altimeter's barometric setting is adjusted while VNAV mode is active, the autopilot increases/decreases the descent rate by up to 500 fpm to re-establish the aircraft on the descent path (without commanding a climb). For large changes, it may take several minutes for the aircraft to reestablish on the descent path.

3.3.3.6.1 AUTOMATIC REVERSION TO PITCH HOLD MODE

Several situations can occur while VNAV Mode is active which cause the AFCS to revert to Pitch Hold Mode:

- The aircraft does not level off at the selected altitude.
- Vertical deviation exceeds 200 feet during an overspeed condition.
- Vertical deviation becomes invalid (the Deviation Indicator is removed from the PFD Page).

Following a reversion to Pitch Hold Mode, VNAV Mode becomes armed to allow for possible profile recapture.

3.3.3.7 GLIDEPATH MODE (GP) (WITH EXTERNAL WAAS ENABLED IFR NAVIGATOR ONLY)

Glidepath Mode is used to track a WAAS or other satellite-based augmentation system WAAS generated glidepath. When Glidepath Mode is armed, 'GP' is annunciated in white in the Autopilot Status Box.

Selecting glidepath mode:

- 1) **EXTERNAL NAVIGATOR:** Ensure a GPS approach with vertical guidance (LPV, LNAV/VNAV, LNAV +V) is loaded into the active flight plan. The active waypoint must be part of the flight plan (cannot be a direct-to a waypoint not in the flight plan).
- 2) Ensure that GPS is the selected navigation source.
- 3) Press the **APR** Key on the GMC 507.



NOTE: Some RNAV (GPS) approaches provide a vertical descent angle as an aid in flying a stabilized approach. These approaches are NOT considered Approaches with Vertical Guidance (APV). Approaches that are annunciated on the HSI as LNAV or LNAV+V are considered Non-precision Approaches (NPA) and are flown to an MDA even though vertical glidepath (GP) information may be provided.



WARNING: When flying an LNAV approach (with vertical descent angle) with the autopilot coupled, the aircraft will not level off at the MDA even if the MDA is set in the altitude preselect.

Upon reaching the glidepath, the flight director transitions to Glidepath Mode and begins to capture and track the glidepath.

Once the following conditions have been met, the glidepath can be captured:

- The active waypoint is at or after the final approach fix (FAF).
- Vertical deviation is valid.
- The CDI is at less than full-scale deviation.
- Automatic sequencing of waypoints has not been suspended.



Figure 3-15 Glidepath Mode

3.3.3.8 GLIDESLOPE MODE (GS)

Glideslope Mode is available for LOC/ILS approaches to capture and track the glideslope. When Glideslope Mode is armed (annunciated as 'GS' in white), LOC Approach Mode is armed as the lateral flight director mode.



NOTE: *Glideslope Mode requires a valid GPS position.*

Selecting Glideslope Mode:

- 1) EXTERNAL NAVIGATOR: Tune and activate the desired localizer frequency.
- 2) EXTERNAL NAVIGATOR: Ensure that LOC is the selected navigation source.
- 3) Press the **APR** Key on the GMC 507.

Or:

- 1) EXTERNAL NAVIGATOR: Tune and activate the desired localizer frequency.
- 2) EXTERNAL NAVIGATOR: Load the approach (LOC, ILS, LDA, SDF, etc) into the flight plan.
- 3) Press the **APR** Key on the GMC 507.

Once LOC is the navigation source, the localizer and glideslope can be captured. Upon reaching the glideslope, the flight director transitions to Glideslope Mode and begins to capture and track the glideslope.



Figure 3-16 Glideslope Mode

3.3.3.9 GO AROUND (GA) AND TAKEOFF (TO) MODES

Go Around and Takeoff modes are coupled pitch and roll modes and are annunciated as both the vertical and lateral modes when active. In these modes, the flight director commands a constant set pitch attitude and keeps the wings level. The GA Switch is used to activate both modes. The mode entered by the flight director depends on whether the aircraft is on the ground or in the air.

Takeoff Mode provides an attitude reference during rotation and takeoff. This mode can be selected only while on the ground by pushing the Go Around Button. The flight director Command Bars assume a wings-level, pitch-up attitude.

Pressing the Go Around Button while in the air activates the flight director in a wings-level, pitch-up attitude, allowing the execution of a missed approach or a go around. Go Around Mode arms Selected Altitude Capture Mode automatically when the altitude preselect bug is set at least 100 ft above the current altitude, and attempts to modify the aircraft attitude (i.e., with the **NOSE UP/DN** Wheel) will result in reversion to Pitch and Roll Hold modes.

3.3.4 LATERAL MODES

The following table lists the lateral modes and respective control(s) and annunciation. Refer to the vertical modes section for information regarding Takeoff and Go Around Modes.

Table 3-6 Flight Director Lateral Modes

Lateral Mode	Description	Control	Annunciation
Roll Hold	Holds the current aircraft roll attitude or rolls the wings level, depending on the commanded bank angle	(default)	ROL
Heading	Captures and tracks the Selected Heading	HDG Key	HDG
Track	Captures and tracks the Selected Ground Track	TRK Key	TRK
Navigation, GPS	Captures and tracks the selected navigation source (GPS, VOR, LOC)	NAV Key	GPS
Navigation, VOR Enroute Capture/ Track			VOR
Navigation, LOC Capture/Track (No Glideslope)			LOC

Table 3-6 Flight Director Lateral Modes

Lateral Mode	Description	Control	Annunciation
Approach, GPS	Captures and tracks the selected navigation source (GPS, VOR, LOC, BC)	NAV Key	GPS
Approach, VOR Capture/Track			
Approach, LOC Capture/Track (Glideslope Mode automatically armed)			LOC
Approach, BC Capture/Track			BC
Takeoff	Commands a constant pitch angle and wings level on-ground in preparation for takeoff	Go Around Button	TO
Go Around	Commands a constant pitch angle and wings level in the air		GA

3.3.4.1 ROLL HOLD MODE (ROL)



NOTE: If Roll Hold Mode is activated as a result of a mode reversion, the flight director rolls the wings level.

When the flight director is activated or switched, Roll Hold Mode is selected by default. This mode is annunciated as 'ROL' in the Autopilot Status Box. The current aircraft bank angle is held, subject to the bank angle condition.

ROL | AP | PIT ALTS

Figure 3-17 Roll Hold Mode Annunciation

Table 3-7 Roll Hold Mode Responses

Bank Angle	Flight Director Response
< 6°	Rolls wings level
6 to 20°	Maintains current aircraft roll attitude
> 20°	Limits bank to 20°

3.3.4.2 HEADING SELECT MODE (HDG)



NOTE: A magnetometer is required for Heading Select Mode (HDG).

Heading Select Mode is activated by pressing the **HDG** Key. Heading Select Mode acquires and maintains the Selected Heading. The Selected Heading is shown by a cyan bug on the HSI and in the box on the bottom right of the HSI.

Changing the selected heading:

- 1) Press the Selection Knob to display the Menu.
- 2) Select **Heading** and use the Selection Knob to change the Selected Heading.

Or

Rotate the **HDG/TRK** Knob.

Activating heading mode:

Press the **HDG** Key on the GMC 507.

Turns are commanded in the same direction as Selected Heading Bug movement, even if the bug is turned more than 180° from the present heading (e.g., a 270° turn to the right). However, Selected Heading changes of more than 330° at a time result in turn reversals.



Figure 3-18 Heading Mode Annunciation

3.3.4.3 TRACK MODE (TRK)

Track Mode is activated by pressing the **TRK** Key on the GMC 507. Track Mode acquires and maintains the Selected Ground Track. The Selected Ground Track is displayed as a magenta bug on the HSI and in the box on the bottom right of the HSI.

Changing the selected ground track:

- 1) Press the Selection Knob to display the Menu.
- 2) Select **Track** and use the Selection Knob to change the Selected Ground Track.

Or

Rotate the **HDG/TRK** Knob.

Activating track mode:

Press the **TRK** Key on the GMC 507.

Turns are commanded in the same direction as Selected Ground Track Bug movement, even if the bug is turned more than 180° from the present heading (e.g., a 270° turn to the right). However, Selected Ground Track changes of more than 330° at a time result in turn reversals.



Figure 3-19 Track Mode Annunciation

3.3.4.4 NAVIGATION MODE (GPS, VOR, LOC)



NOTE: The G5 must have a valid GPS position for VOR and LOC Modes.



NOTE: Dual navigators are supported for the GFC 500.



NOTE: When intercepting a flight plan leg, the flight director gives commands to capture the active leg at approximately a 45° angle to the track between the waypoints defining the active leg. The flight director does not give commands fly to the starting waypoint of the active leg.

Pressing the **NAV** Key selects Navigation Mode. Navigation Mode acquires and tracks the navigation source. The flight director follows GPS roll steering commands when GPS is the navigation source. Navigation Mode can also be used to fly non-precision GPS, VOR, and LOC approaches where vertical guidance is not required.

If the Course Deviation Indicator (CDI) shows greater than one dot when the **NAV** Key is pressed, the selected mode is armed. If the CDI is less than one dot, Navigation Mode is automatically captured when the **NAV** Key is pressed. The armed annunciation appears in white to the left of the active roll mode.



Figure 3-20 Navigation Mode Annunciation

If Navigation Mode is active and either of the following occur, the AFCS reverts to Roll Hold Mode (wings rolled level):

- Active navigation source manually switched
- Navigation input is lost
- GPS reception is lost

3.3.4.5 APPROACHES WITHOUT VERTICAL GUIDANCE



NOTE: The selected navigation receiver must have an active GPS course for the flight director to enter Approach Mode.

Press the **NAV** Key to arm/activate GPS (LNAV only) lateral mode. The lateral mode acquires and tracks the selected navigation source, depending on the loaded approach. Press **NAV** when the CDI is greater than one dot to arm the selected mode (annunciated in white). Press **NAV** when the CDI deviation is less than one dot to activate, capture and track the selected navigation source.

Table 3-8 Approach Without Vertical Guidance

Example	Control	Lateral Mode	Annunciation	Description
LNAV	NAV Key	Approach, GPS	GPS	Captures and tracks the selected navigation source (GPS, VOR, LOC, BC)
VOR		VOR Approach Capture/Track	VOR	
LOC		LOC Approach Capture/Track	LOC	
BC		BC Approach Capture/Track	BC	

3.3.4.5.1 GPS APPROACH WITHOUT VERTICAL GUIDANCE

A GPS approach without vertical guidance (LNAV) is flown using GPS NAV Mode.

Selecting a GPS Approach without vertical guidance:

- 1) **EXTERNAL NAVIGATOR:** Ensure a GPS approach without vertical guidance (LNAV) is loaded into the active flight plan.
- 2) **EXTERNAL NAVIGATOR:** Ensure the 'GPS' indication is showing in the lower-left corner. If not, press the CDI Key on the navigator.
- 3) **EXTERNAL NAVIGATOR:** Select and activate the GPS approach using the PROC Key.
- 4) Press the **NAV** Key.
- 5) Adjust the aircraft's pitch axis as required.

3.3.4.5.2 VOR APPROACH

A VOR approach is flown using VOR Mode.

Selecting a VOR Approach:

- 1) EXTERNAL NAVIGATOR: Tune and activate the desired VOR frequency.
- 2) EXTERNAL NAVIGATOR: Ensure the 'VLOC' indication is showing in the lower-left corner. If not, press the **CDI** Key on the navigator.
- 3) Ensure that VOR1 or VOR2 is the selected navigation source on the HSI Page. It should say 'VOR1' or 'VOR2' on the HSI and the needle should be green.
- 4) From the HSI Page, press the Selection Knob to display the Menu.
- 5) Set the inbound approach course. Select **Course** and use the Selection Knob to adjust the course.
- 6) Press or the **NAV** Key on the GMC 507.

If there is less than half-scale deviation when the **NAV** Key is pressed, VOR Mode will activate (green text), intercept, and track the selected radial. If there is more than half-scale deviation when the **NAV** Key is pressed, VOR Mode will arm (white text) first, then activate when closer to the radial.

- 7) Adjust the aircraft's pitch axis as required.

3.3.4.5.3 LOCALIZER APPROACH (No GS)

LOC Mode is used to fly a localizer only approach (no glideslope).

Selecting LOC Mode for a localizer only approach:

- 1) EXTERNAL NAVIGATOR: Tune and activate the desired LOC frequency,
- 2) Ensure the 'LOC1' indication is showing in the lower-left corner. If not, press the CDI Key on the navigator. The HSI should automatically slew the needle to the correct course.
- 3) Press or the **NAV** Key on the GMC 507.

If the localizer deviation is less than half-scale when the **NAV** Key is pressed, the autopilot will activate LOC Mode and track the localizer, otherwise LOC Mode is armed and the pilot is responsible for intercepting the localizer. In some cases it may be necessary to use HDG Mode with LOC Mode armed to follow a vector to the localizer.

3.3.4.6 GPS APPROACHES WITH LATERAL + VERTICAL GUIDANCE

Press the **APR** Key to arm/activate both lateral and vertical modes for approach. When Glidepath (GP) Mode is armed for a GPS approach with vertical guidance, GPS Mode is automatically armed. Press the **APR** Key when the CDI is greater than one dot to arm the selected modes (annunciated in white). Press the **APR** Key when the CDI deviation is less than one dot to activate, capture and track the selected navigation source.

Table 3-9 Lateral + Vertical Approaches

Example	Control	Modes	Annunciation	Description
LPV, LNAV/VNAV, LNAV+V	APR Key	Lateral: GPS	GPS	Captures and tracks the lateral portion of a GPS approach
		Vertical: Glidepath	GP	Captures and tracks a WAAS approach glidepath
LOC, ILS	APR Key	Lateral: Localizer	LOC	Captures and track the localizer
		Vertical: Glideslope	GS	Captures and tracks the glideslope

3.3.4.7 GPS APPROACH WITH VERTICAL GUIDANCE



NOTE: To cancel Glidepath (GP) Mode without cancelling GPS Mode, press **NAV** once. Pressing it a second time cancels GPS Mode.

When Glidepath (GP) Mode is armed for a GPS approach with vertical guidance, GPS Mode is automatically armed.

Selecting a GPS approach with vertical guidance:

- 1) **EXTERNAL NAVIGATOR:** Ensure a GPS approach with vertical guidance (LPV, LNAV/VNAV, LNAV+V) is loaded into the active flight plan.
- 2) **EXTERNAL NAVIGATOR:** Ensure the 'GPS' indication is showing in the lower-left corner. If not, press the **CDI** Key.
- 3) **EXTERNAL NAVIGATOR:** Select and activate the GPS approach using the **PROC** Key.
- 4) Press the **APR** Key.

3.3.4.8 LOCALIZER WITH GLIDESLOPE

LOC Mode (lateral) and GS Mode (vertical) are both armed by pressing the **APR** Key on the GMC 507. LOC/ILS approach captures are inhibited if the difference between aircraft heading and localizer course exceeds 105°.



NOTE: To cancel Glideslope (GS) Mode without cancelling LOC Mode, press **NAV** once. Pressing it a second time cancels LOC Mode.

Selecting LOC Mode with GS Mode:

- 1) EXTERNAL NAVIGATOR: Tune and activate the desired LOC frequency.
- 2) EXTERNAL NAVIGATOR: Ensure the 'LOC1' indication is showing in the lower-left corner. If not, press the CDI Key. The HSI should automatically slew the needle to the correct course.
- 3) Press the **APR** Key on the GMC 507.

This simultaneously selects LOC Mode and GS (Glideslope) Mode. If the localizer deviation is less than half-scale when the APR Key is pressed, the autopilot will activate LOC Mode and track the localizer, otherwise LOC Mode is armed and the pilot is responsible for intercepting the localizer.

If the following occurs, the autopilot reverts to Roll Hold Mode (wings rolled level):

- Approach Mode is active and the Navigation source is manually switched
- The localizer signal is lost

If the Glideslope signal is lost, GS Mode will revert to Pitch Hold Mode and hold the last pitch attitude.

3.3.4.9 BACKCOURSE APPROACH



NOTE: When making a backcourse approach, set the Selected Course to the localizer front course.

Backcourse Mode captures and tracks a localizer signal in the backcourse direction. Backcourse is indicated by 'BC' in the autopilot status box.

If GS and LOC Mode are armed, the autopilot can only capture the localizer front course, indicated by 'LOC' in the autopilot status box. If only LOC Mode is armed (not GS Mode), the autopilot will capture either the front course or the backcourse based on the angle at which the aircraft intercepts the localizer.

Selecting BC Mode:

- 1) EXTERNAL NAVIGATOR: Tune and activate the desired LOC frequency.
- 2) EXTERNAL NAVIGATOR: Ensure the 'LOC1' indication is showing in the lower-left corner. If not, press the **CDI** Key.
- 3) EXTERNAL NAVIGATOR: Select the front course on the CDI.
- 4) Press the **NAV** Key on the GMC 507.



NOTE: If the aircraft heading is within 75° of the localizer backcourse then BC Mode will be armed. If the aircraft heading is within 105° of the localizer front course, LOC Mode will be armed.

3.3.4.10 LEVEL MODE

Level Mode is coupled in pitch and roll modes and is annunciated as both the vertical and lateral modes when active. Pressing the **LVL** Key engages the autopilot in Level vertical and lateral modes. Level Mode does not track altitude or heading. When the **LVL** Key is pressed all armed and active modes are cancelled and the autopilot and flight director revert to LVL mode for pitch and roll. While in level mode, all other modes are available by pressing the corresponding key.

3.4 GFC 500 AFCS ALERTS

3.4.1 TRIM ALERTS

If the commanded operation cannot be achieved due to the limitations configured, the following messages can be displayed over the pitch scale. The annunciation is removed once the condition is resolved.



Figure 3-21 TRIM UP Alert



Figure 3-22 TRIM DOWN Alert

Alert Condition	Annunciation	Description
Up-elevator Trim Required	TRIM UP	The autopilot does not have the required elevator authority to reach the desired flight condition.
Down-elevator Trim Required	TRIM DOWN	

Table 3-10 Status Alerts

3.4.2 SPEED ALERTS

If the remote autopilot unit supports speed alerts and the airspeed limitations configured have been reached, the following messages can be displayed the airspeed tape. The annunciation is removed once the condition is resolved.

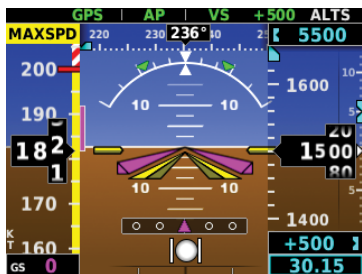

Figure 3-23 MAXSPD Alert



Figure 3-24 MINSPD Alert

Alert Condition	Annunciation	Description
High speed Protection	MAXSPD	Autopilot unit will raise the nose to limit the aircraft's speed.
Low speed Protection	MINSPD	Autopilot unit will lower the nose to prevent the aircraft's speed from decreasing.

Table 3-11 Speed Alerts

3.4.3 GFC 500 MESSAGES AND ANNUNCIATIONS

Table 3-12 GFC 500 Messages and Annunciations

Autopilot Messages	
AFCS Controller Key Stuck	The system has sensed a key input on the GMC 507 for 30 seconds or longer.
AFCS Controller Audio Database Missing	The audio database is missing from the GMC 507. The aural voice alerts will not be heard.
Servo Clutch Fault	One or more autopilot servos has a stuck clutch. The servo needs service.

Table 3-12 GFC 500 Messages and Annunciations

Servo Trim Input Fault	The inputs to the trim system are invalid. The trim system needs service.
Autopilot Annunciations	
AFCS	Autopilot has failed. Autopilot and trim are inoperative and flight director is not available.
AP	Autopilot normal disconnect.
AP	Autopilot abnormal disconnect.
AP	Autopilot has failed. The autopilot is inoperative. FD modes may still be available.
PFT	Autopilot preflight test is in progress.
PTRIM	Pitch Trim Fail – Manual Electric Pitch Trim is inoperative.

3.5 ELECTRONIC STABILITY & PROTECTION (ESP) (GFC 500)



WARNING: Do not assume ESP will provide stability protection in all circumstances. There are in-flight situations that can exceed the capabilities of ESP technology.



WARNING: A GPS navigator that can provide AGL height data is required for low-air-speed protection.



WARNING: The autopilot (or ESP) will disengage if the roll attitude exceeds 75° or the pitch attitude exceeds 50°.

Electronic Stability and Protection (ESP) is a feature that is intended to monitor the aircraft and provide control input feedback when necessary to discourage operating the aircraft at potentially unsafe attitudes and/or airspeeds. If enabled, this feature will automatically arm when the aircraft is above 500 feet AGL and the autopilot is not engaged, and disarm when below 200 feet AGL (if AGL height data is unavailable, ESP can be armed on the ground, but low-air-speed protection will not be available).

When selected, ESP engages automatically when the aircraft approaches or exceeds one or more predetermined airspeed or attitude limitations. Stability protection for each flight axis is provided by the autopilot servos, which apply force to the appropriate control surface(s) to discourage pilot control inputs that would cause the aircraft to exceed the normal or "protected" flight envelope. This is perceived by the pilot as resistance to control movement in the undesired direction when the aircraft approaches a steep attitude, and/or the airspeed is below the minimum or above the maximum configured airspeed.

As the aircraft deviates further from the normal attitude and/or airspeed, the force increases proportionally (up to an established maximum) to encourage control movement in the direction necessary to return to the normal attitude and/or airspeed range.

When ESP has been engaged for more than 10 seconds (cumulative; not necessarily consecutive seconds) of a 20-second interval, the autopilot can be configured to engage with the flight director in Level Mode, bringing the aircraft into level flight. An aural "Engaging Autopilot" alert is played and the flight director mode annunciation will indicate 'LVL' for vertical and lateral modes.

Level mode as activated by ESP is limited by altitude. ESP will not be able to activate Level mode until the aircraft climbs above 2000 feet AGL. ESP will be locked out of automatically activating Level mode after the aircraft descends below 1500 feet AGL as well. Also note that Level mode as activated by ESP is different than manually selected Level mode. Manually selected Level mode is not limited by altitude at all.



NOTE: *If AGL height data is unavailable automatic engagement of Level mode is not supported.*

ESP is enabled or disabled from the PFD Page Menu.

Enabling/Disabling ESP using the G5 Menu:

- 1) From the PFD Page, press the Selection Knob to display the Menu.
- 2) Turn the Selection Knob to highlight **ESP**.
- 3) Press the Selection Knob to enable or disable ESP.

ESP Roll Engagement Indication (ESP NOT Engaged)



Figure 3-25 AFCS (ESP Enabled)

3.5.1 ROLL ENGAGEMENT

Roll Limit Indicators displayed on the roll scale are configurable between 45° and 60° right and left, indicating where ESP will engage. As roll attitude exceeds the configured limit, ESP will engage and the Roll Limit Indicators will move to 15° less than the configured ESP bank limit. The Roll Limit Indicator now indicates where ESP will disengage as roll attitude decreases.

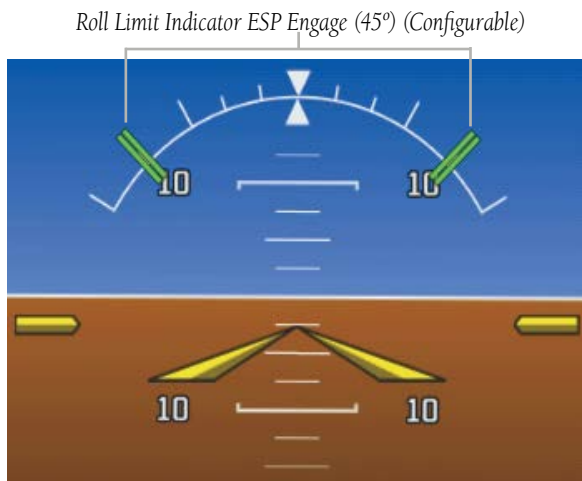

Figure 3-26 ESP Roll Engagement Indication (ESP Enabled but NOT Engaged)

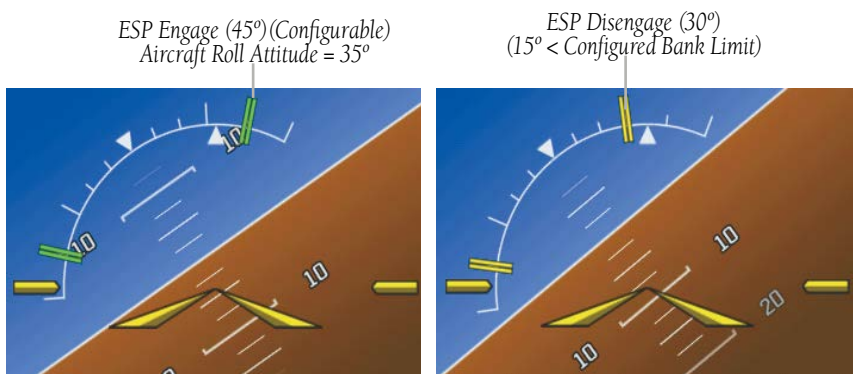

Figure 3-27 Roll Increasing to ESP Engagement

Once engaged, the torque applied by ESP is at its maximum when bank angle is 15° more than the configured bank limit, and tapers to the minimum applied torque when the bank angle is 15° less than the configured bank limit. The force increases as roll attitude increases and decreases as roll attitude decreases. The applied force is intended to encourage pilot input to return the airplane to a more normal roll attitude. When beyond 15° of the configured bank limit, the maximum torque is held until the aircraft returns inside the protected envelope.

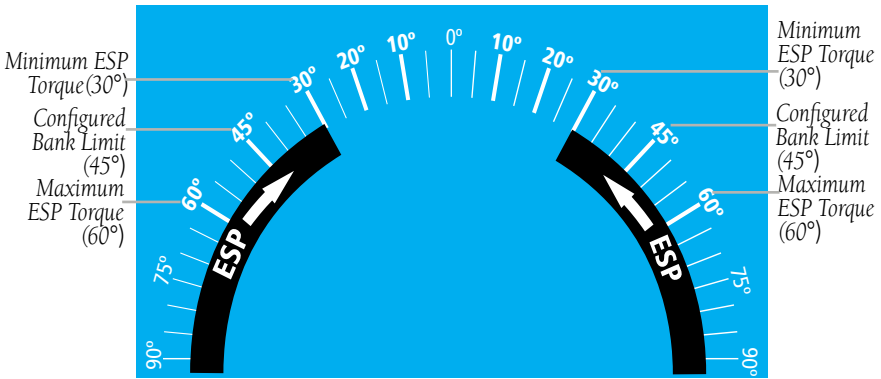

Figure 3-28 ESP Roll Operating Range When Engaged
 (Force Increases as Roll Increases & Decreases as Roll Decreases)

3.5.2 PITCH ENGAGEMENT

ESP pitch engagement is configurable between 10° and 25° nose-up and between 5° and 25° nose-down. Once engaged, the torque applied by ESP is at its maximum when pitch is 5° more than the configured nose-up and nose-down pitch limits, and tapers to the minimum applied torque when pitch is 5° less than the configured nose-up and nose-down pitch limits. When beyond 5° of the configured pitch limit, the maximum torque is held until the aircraft returns inside the protected envelope.

The opposing force increases or decreases depending on the pitch angle and the direction of pitch travel. This force is intended to encourage movement in the pitch axis in the direction of the normal pitch attitude range for the aircraft.

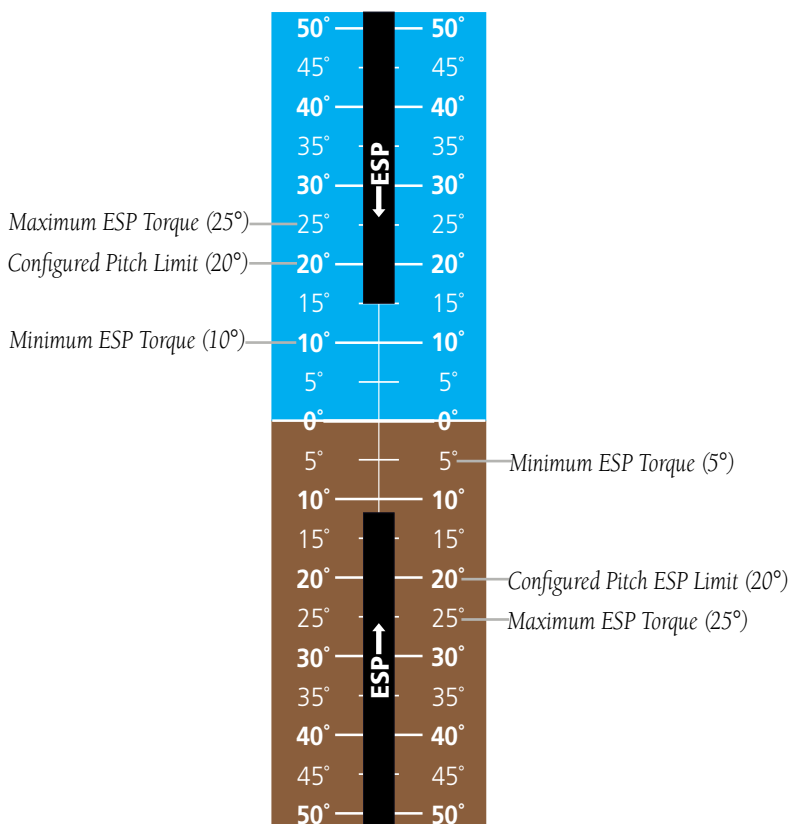

Figure 3-29 ESP Pitch Operating Range When Engaged
(Force Increases as Pitch Increases & Decreases as Pitch Decreases)

3.5.3 AIRSPEED PROTECTION (GFC 500 ONLY)



NOTE: *If AGL height data is unavailable low-airspeed protection is not supported.*

An airspeed below the minimum configured airspeed or above maximum configured airspeed will result in ESP applying force to raise or lower the nose of the aircraft. When the high or low airspeed condition is remedied, ESP force is no longer applied.

Blank Page

SECTION 4 ADDITIONAL FEATURES

4.1 GPS STEERING (GPSS)



NOTE: This section is only applicable to non-Garmin autopilots.

When installed with the appropriate interfaces, the G5 can interface to some third-party autopilot systems.

4.1.1 GAD 29B (OPTIONAL)

The GAD 29B (optional) is an adapter that converts digital heading and course data into analog signals used by analog autopilot systems. The GAD 29B is installed remotely between the G5 and an existing autopilot. The analog signals from the GAD 29B mimic those of spinning-mass heading gyros that provide data to the autopilot and allow the gyro to be replaced by the G5 and GAD 29B combination. The GAD 29B is also used to interface certain Garmin IFR navigators with the G5.

The GAD 29B sends analog information about the G5's heading bug to a third-party analog autopilot, allowing it to operate in HDG mode and follow the G5 heading bug. The navigation course selected on the G5 is also sent to the analog autopilot, enabling proper operation of the autopilot's NAV mode.



NOTE: If multiple navigators are configured, course data is sent by the GAD 29B for navigator #1 only.



Figure 4-1 GAD 29B (Optional)

GPS Steering (GPSS) provides roll command signals calculated by the GPS navigator to the autopilot in order to allow the aircraft to anticipate turns, make smooth transitions when passing waypoints, and fly leg types such as procedure turns and holding patterns.

Some autopilots have built-in support for GPS Steering (GPSS) commands from a GPS navigator. These autopilots receive digital GPSS commands directly from the navigator. Refer to the Airplane Flight Manual and autopilot system documentation for instructions on how to use the autopilot's GPSS function.

For older autopilots that do not have built-in support for digital GPSS signals, GPSS functionality may be emulated using the analog heading bug output of the G5 and GAD 29B, by operating the autopilot in HDG mode and selecting GPSS from the G5 menu.



NOTE: If multiple navigators are configured, GPSS emulation is supported for navigator #1 only.



NOTE: GPSS commands are not sent to the autopilot when a VLOC source is displayed on the HSI.

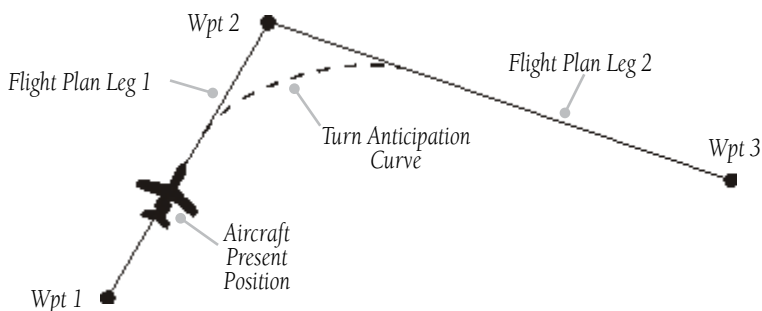

Figure 4-2 GPSS Turn Anticipation

Enabling/Disabling GPSS Mode:

- 1) Press the Selection Knob to display the Menu.
- 2) Turn the Selection Knob to select **GPSS**.
- 3) Press the Selection Knob to enable/disable **GPSS** Mode.

When GPSS is selected on the G5, the heading bug will change to a hollow outline, and a crossed-out heading bug symbol appears on the G5 indicating that the autopilot is not coupled to the heading bug. The heading bug is still controllable and may still be used for reference.

When the G5 and GAD 29B are providing analog GPSS emulation, GPSS turn commands from the navigator are converted into a heading error signal to the autopilot. When the autopilot is operated in HDG mode, the autopilot will fly the turn commands from the GPS navigator. If the GPSS data is invalid (for example, if there is not active GPS leg) or the selected HSI source on the G5 is not GPS, the annunciated "GPSS" text will turn amber and a zero turn command will be sent to the autopilot.



Figure 4-3 GPSS Enabled - PFD

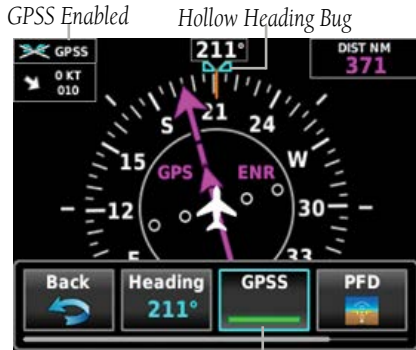

Figure 4-4 GPSS Enabled - HSI

A

AFCS Operation 39
Airspeed Indicator 14
Altimeter 18–19
Altitude Alerting 19
Altitude Hold Mode (ALT) 50
Approach Mode 62
Attitude and Heading Reference System (AHRS) 6, 7
Attitude Indicator 16
Automatic Reversion 54
Autopilot 39
Autopilot Disconnect 42

B

Barometric setting, Altimeter 17–18, 19–20
Bearing Pointers 27

C

Command Bars 46

D

Display
 Overview 3

E

Electronic Stability & Protection 40

F

Flight Director 39
Flight Level Change Mode 52

G

GFC 500 35
Glidepath Mode (GP) 55
GMC 507 36
GSA 28 36

H

Heading Select Mode 59, 60
Heading Strip 20
Horizontal Situation Indicator (HSI) 28

I

Integrated Autopilot
 Disengaging 42
 Engaging 42

M

Manual Electric Trim 40
MENU Key 4
Menus 8, 9, 11
Messages
 Miscellaneous 10, 11, 67, 68

N

Navigation Mode 61–62
NRST Key 4

P

Pitch Hold Mode 48

R

Roll Hold Mode 58

S

- Secure Digital (SD) Cards 4
 - Installing 4
- Selected Altitude 48, 49, 51
- Selected Altitude Capture Mode 48, 49, 51, 57
- Selected Heading 28, 59, 60

System

- Annunciations 5
- Functionality 8
- Initialization 5

T

- Takeoff Mode 56

V

- Vertical Deviation Indicator (VDI) 30
- Vertical Speed Indicator (VSI) 22, 29
- Vertical Speed Mode 51

Y

- Yaw Damper 40



Garmin International, Inc.
1200 East 151st Street
Olathe, Kansas 66062, U.S.A.

Garmin AT, Inc.
2345 Turner Road SE
Salem, OR 97302, U.S.A.

Garmin (Europe) Ltd.
Liberty House, Hounsdown Business Park
Southampton, Hampshire SO40 9LR U.K.

Garmin Corporation
No. 68, Zhangshu 2nd Road
Xizhi District, New Taipei City, Taiwan

Contact Garmin Product Support at
www.flygarmin.com